

# SG 4770

---

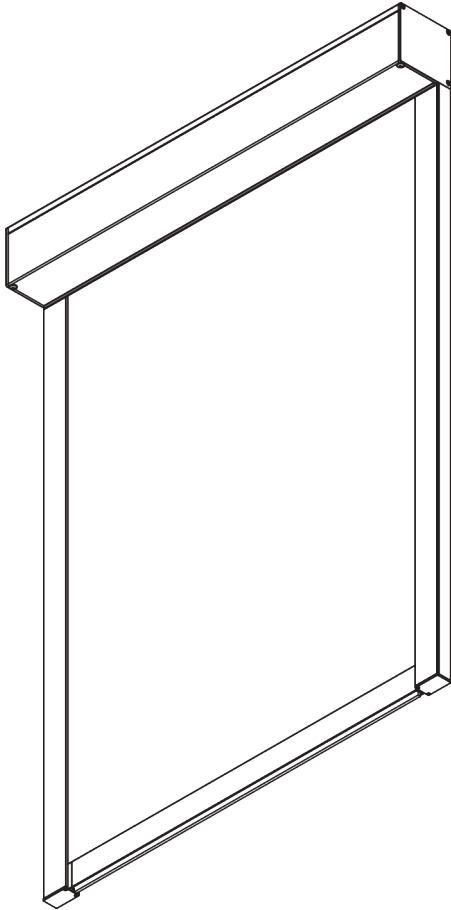
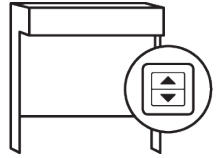

## PRODUKTINFORMATIONEN

- **Bedienung:** Motor
- **Grösse:** M
- **Montage:** Decke, Wand, Nische
- **Farben:** weiss RAL 9016 oder schwarz RAL 9005, Sonderfarben möglich
- **Stoffe:** siehe Silent Gliss Stoffkollektion

### **Merkmale:**

- Zip Technologie
- Leise und schnelle Motoren
- Soft-Stop
- Vielfältige Steuerungsmöglichkeiten
- 40 mm Seitenprofil, Vorgebohrte Träger Positionierungen

01/2025/V1

# SYSTEMSPEZIFIKATIONEN

## A. MASSE / GEWICHT

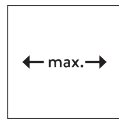

2.2 m

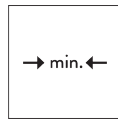

65 cm\*

\*siehe

Motorspezifikationstabelle

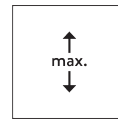

2.4 m



5.3 m<sup>2</sup>



3.7 kg

## B. PROFIL

### Profilinformationen

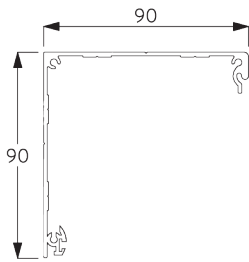

**SG 10996**

Kassettengehäuse 90 mm

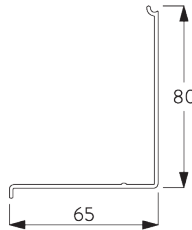

**SG 10997**

Kassettendeckel 90 mm

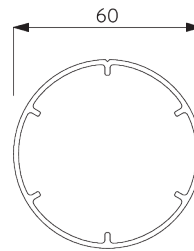

**SG 11037**

Rohr ø 60 mm

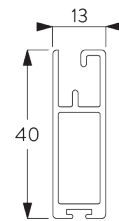

**SG 10993**

Beschwerung

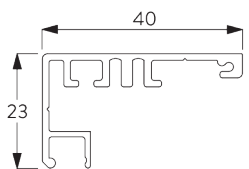

**SG 11418**

Seitliche Führungsschiene



**SG 11419**

Seitliche Abdeckung

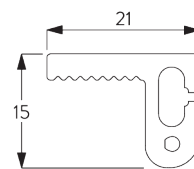

**SG 11421**

Zip-Profil

## C. MASSAUFNAHME

### Untermontage

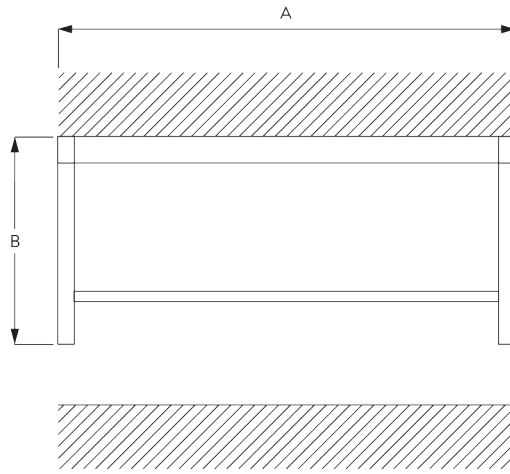

A: Systembreite  
B: Systemhöhe

### Aufmontage

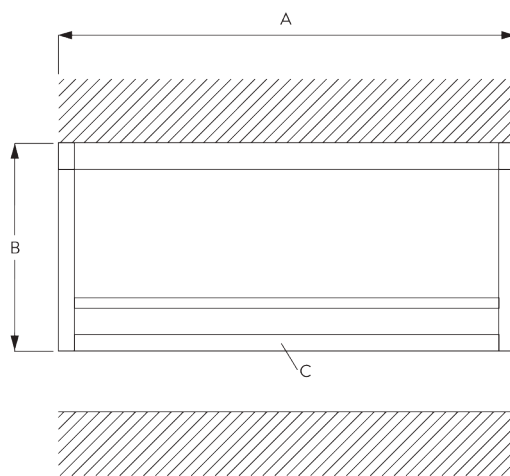

A: Systembreite  
B: Systemhöhe  
C: Optional: Abschlussprofil (SG 11418 / SG 11419)

# MONTAGE

## A. MONTAGE- INFORMATIONEN

Detaillierte Montageinformationen siehe  
Silent Gliss Website

### Montagepunkte - Decken-/ Untermontage

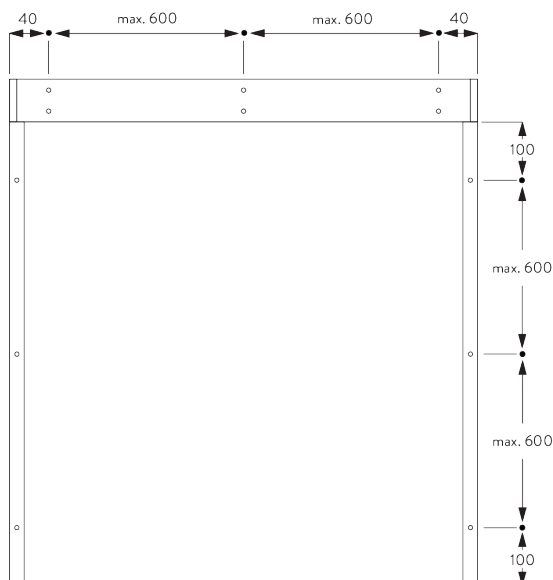

**Montagepunkte -  
Wand-/Aufmontage**

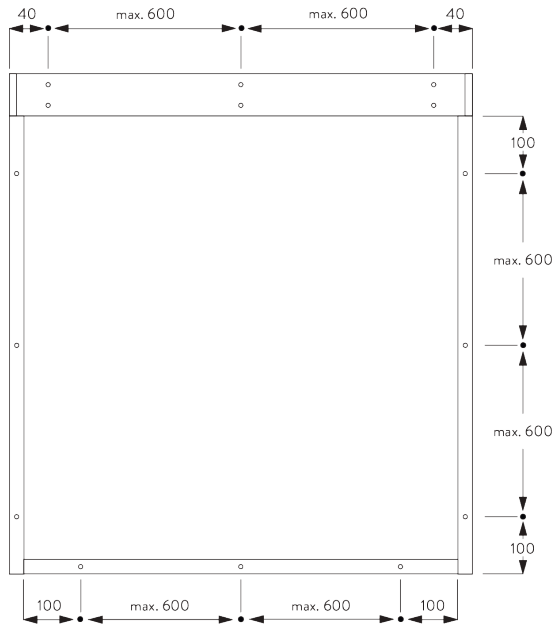

**B. DECKEN-/  
UNTERMONTAGE**

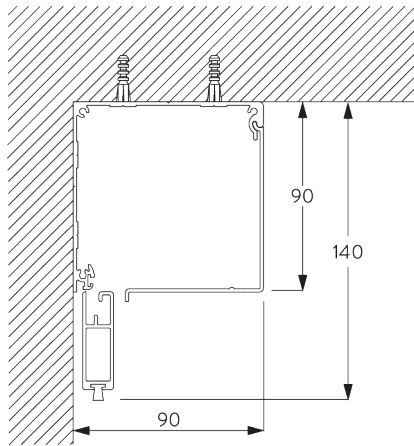

**C. WAND-/  
AUFMONTAGE**

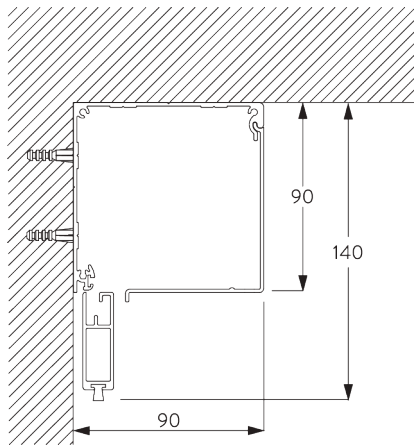

**D. NISCHEN-  
MONTAGE**

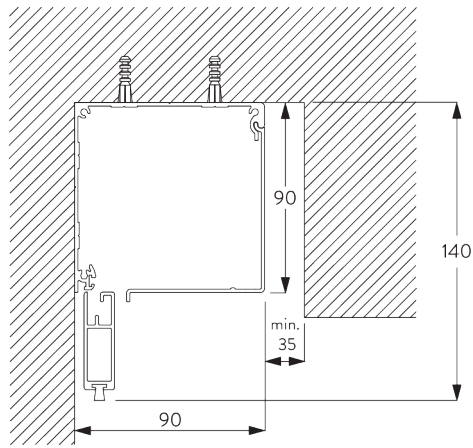

**E. SEITENPROFILE  
SG 11418 / SG 11419**

**Untermontage**

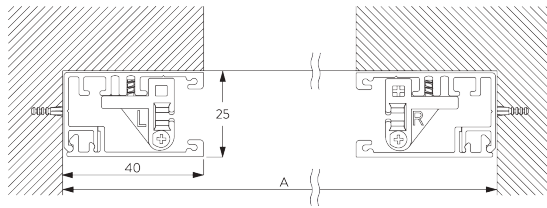

A: Systembreite

**Aufmontage**

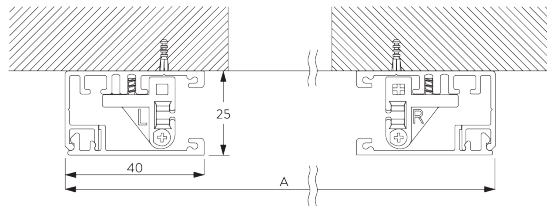

A: Systembreite

# MOTOREN UND BEDIENUNGSARTEN

## A. MOTOREN- MERKMALE

Motoren	50-Serie	20-Serie	20-Serie	10-Serie K	5-Serie
	SG 11251	SG 10523	SG 10522	SG 10514	SG 10715

### Motoreigenschaften

Soft-Stop	•	•	•		
Elektronische Endposition	•	•	•		
Elektronischer Umdrehungszähler (Umdrehungszahl unbegrenzt)	•	•	•		
Mechanische Endposition				•	•
Mechanischer Umdrehungszähler (Umdrehungszahl begrenzt)				•	•
Zwei Zwischenpositionen möglich		•			
Ausrichtung der Beschwerungsprofile	•				
Geräuschloser Stopp		•	•	•	
Parallelschaltung möglich ohne zusätzliche Relais		•	•		
Anschlusskabel an Motor ansteckbar	•	•	•		
IP Klasse	IP 30	IP 44	IP 44	IP 44	IP 44

### Steuerungsmöglichkeiten

Netzstrom		•	•	•	•
SG Control L (eingebauter Funkempfänger)		•			
Smart by Silent Gliss	•				
Geeignet für alle gängigen Hausautomationssysteme (mit passender Schnittstelle)		•	•	•	•

## B. MOTOREN- SPEZIFIKATIONEN

Siehe Website für  
Schaltschema.

Motoren	Min. System- breite	Spannung	Stromstärke	Frequenz	Drehzahl	Funkfrequenz Empfänger
<b>50-Serie (Smart by Silent Gliss)</b>						
SG 11251	65 cm	24 V DC	1.5 A	-	32 U/Min	-
<b>20-Serie</b>						
SG 10522 (Standard)	65 cm	230 V AC	0.55 A	50 Hz	30 U/Min	-
SG 10523	65 cm	230 V AC	0.55 A	50 Hz	30 U/Min	868/915 MHz
<b>10-Serie K</b>						
SG 10514	65 cm	230 V AC	0.52 A	50 Hz	30 U/Min	-
<b>5-Serie</b>						
SG 10715	65 cm	230 V AC	0.485 A	50-60 Hz	28 U/Min	-

## C. BEDIENUNGS- ARTEN

Siehe Katalog "Steuerungen" für mehr Details.

Wandschalter



Bedienbar mit drahtgebundenem Wandschalter.

## SG Control L



*Verschiedene Funkfernsteuerungen erhältlich.*



*Silent Gliss Move App.*

## Smart by Silent Gliss



*Offenes Zwei-Weg-Kommunikationssystem, das eine problemlose Integration der Produkte mit den meisten gängigen Gebäudemanagementsystemen ermöglicht.*













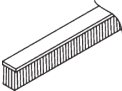

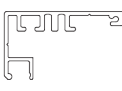
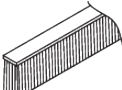

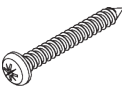

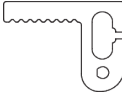
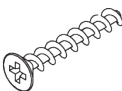



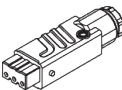
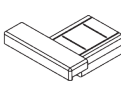
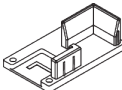

## D. SCHALTSCHHEMA

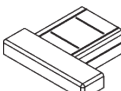
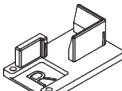

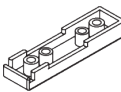
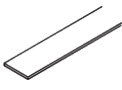
*Siehe Silent Gliss Website.*

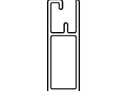
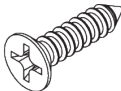
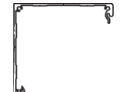



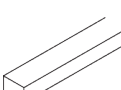





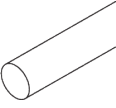
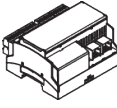
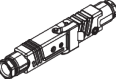
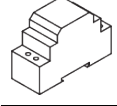
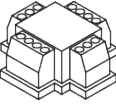
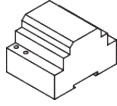
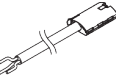
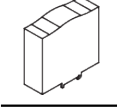

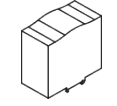
# KOMPONENTEN

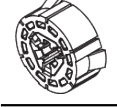
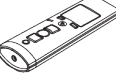
## A. STANDARD KOMPONENTEN

	<b>SG 4226</b> Doppelklebeband 30 mm		<b>SG 11007</b> Enddeckel rechts 90 mm		<b>SG 11324</b> PT Schraube Senkkopf KA35x14
	<b>SG 4508</b> Bürste 5x7 mm		<b>SG 11011</b> Clip		<b>SG 11418</b> Seitliche Führungsschiene
	<b>SG 4509</b> Bürste 5x12 mm		<b>SG 11013</b> Clip für Motorantrieb		<b>SG 11419</b> Seitliche Abdeckung
	<b>SG 6791</b> Linsenschraube 3.9x32		<b>SG 11017</b> Rohr Adapter 60 mm		<b>SG 11421</b> Zip-Profil
	<b>SG 6933</b> PT Senkkopfschraube KA25x16		<b>SG 11019</b> Rohr Adapter Motor 60 mm		<b>SG 11473</b> Zip Führung links
	<b>SG 6936</b> PT Senkkopfschraube KA22x10		<b>SG 11025</b> Zip		<b>SG 11474</b> Zip Führung rechts
	<b>SG 9917</b> Hirschmann Kupplung STAK 3 N		<b>SG 11028</b> Enddeckel links		<b>SG 11475</b> Enddeckel links für Seitenführung
	<b>SG 10284</b> O-Ring ø12.1x2.7		<b>SG 11029</b> Enddeckel rechts		<b>SG 11476</b> Enddeckel rechts für Seitenführung
	<b>SG 10522</b> Motor 230V AC, 20er Serie S 3/30		<b>SG 11030</b> Deckel		
	<b>SG 10668</b> PVC Streifen 10 mm		<b>SG 11034</b> Senkkopfschraube 3.5x16		
	<b>SG 10993</b> Beschwerung		<b>SG 11035</b> Senkkopfschraube 2.2x9.5		
	<b>SG 10996</b> Kassettengehäuse 90 mm		<b>SG 11037</b> Rohr ø 60 mm		
	<b>SG 10997</b> Kassettendeckel 90 mm		<b>SG 11059</b> Linsenschraube mit Flansch M4x12		
	<b>SG 11006</b> Enddeckel links 90 mm		<b>SG 11060</b> Schaumklebeband		

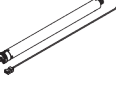
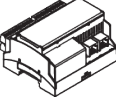
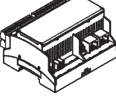

## B. OPTIONALE KOMponentEN

	<b>SG 4951</b> Beschwerung ø 8 mm		<b>SG 11262</b> Erweiterung
	<b>SG 9916</b> Hirschmann Kupplungsset		<b>SG 11263</b> Transformer 24V DC, 2.5 Ampere DIN Rail
	<b>SG 9959</b> Trennrelais		<b>SG 11264</b> Transformer 24V DC, 3.8 Ampere DIN Rail
	<b>SG 10293</b> Anschlusskabel 230V AC, 2/3/5/10 m		<b>SG 11265</b> Transformer 24V DC, 5 Ampere DIN Rail
	<b>SG 10300</b> Funkhandsender 1-Kanal		<b>SG 11266</b> Transformer 24V DC, 10 Ampere DIN Rail
	<b>SG 10302</b> Funkhandsender 5+1-Kanal		<b>SG 11359</b> Mitnehmerset 5er Serie
	<b>SG 10303</b> Funkhandsender 10+2+1-Kanal		<b>SG 11460</b> Deckel für Hirschmann Stecker
	<b>SG 10514</b> Motor 230V AC, 10er Serie S 3/30 K		<b>SG 11480</b> Funkhandsender 1-Kanal
	<b>SG 10523</b> Motor 230V AC, 20er Serie S 3/30, Funkempfänger		<b>SG 11490</b> Funkhandsender 5+1-Kanal
	<b>SG 10715</b> Motor 230V AC, 5er Serie S 6/28		
	<b>SG 10804</b> Funkhandsender 15+5+1 Kanal		
	<b>SG 11251</b> Motor 24V DC, 50er Serie S 3/32		
	<b>SG 11260</b> Gateway Cedia		
	<b>SG 11261</b> Gateway KNX		





