

SG 1011

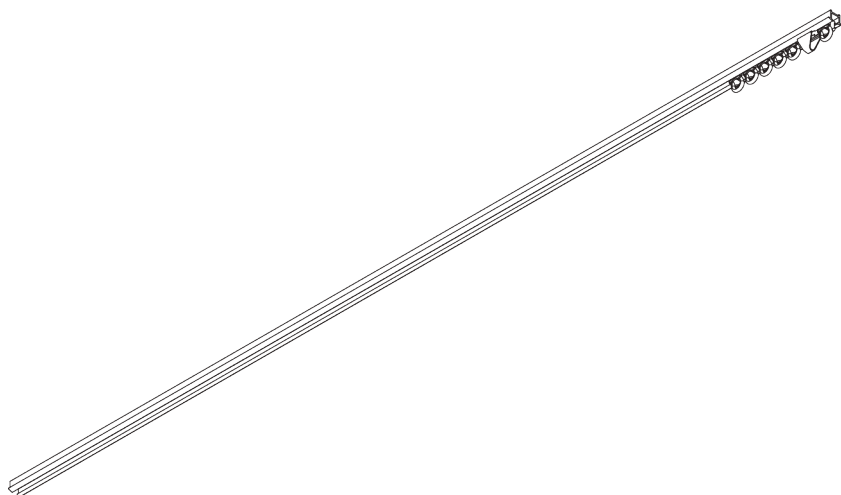

PRODUKTINFORMATIONEN

- **Bedienung:** Hand
- **Grösse:** S
- **Montage:** Nut (Center SG 7550)
- **Farben:** weiss RAL 9016 oder Aluminium farblos eloxiert, Sonderfarben möglich
- **Stoffe:** siehe Silent Gliss Stoffkollektion

Merkmale:

- Vorgebohrtes Profil
- Biegbar

SYSTEMSPEZIFIKATIONEN

A. PROFIL

Profil- und
Biegeinformationen

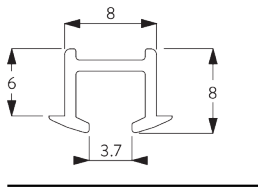

SG 1011p

Profil

Radius:
✓ 6 cm, 10 cm

B. MASSAUFNAHME

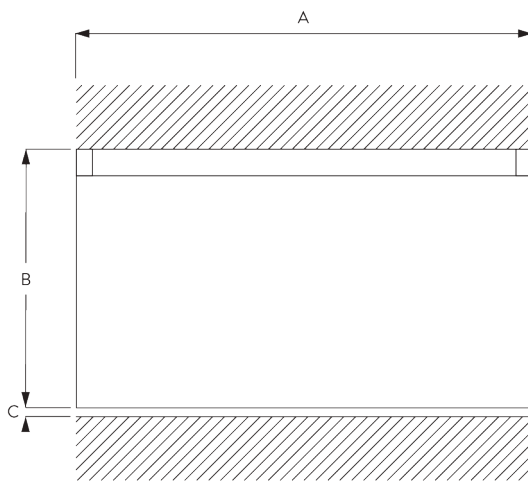

A: Systembreite

B: Systemhöhe

C: Abstand zwischen Boden und Behang

MONTAGE

A. MONTAGE- INFORMATIONEN

Detaillierte Montageinformationen siehe
Silent Gliss Website

Montagepunkte

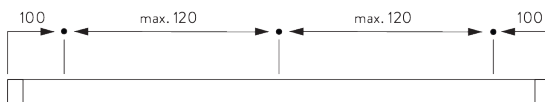

Profilschutz

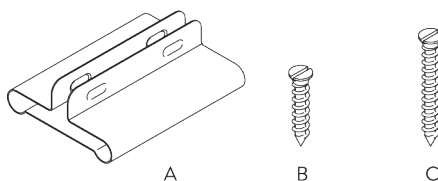

A: Profilschutz SG 7002

B: Spezialschraube SG 3019 / 12 mm

C: Spezialschraube SG 3025 / 18 mm

B. NUT MONTAGE

Direkt ins Holz

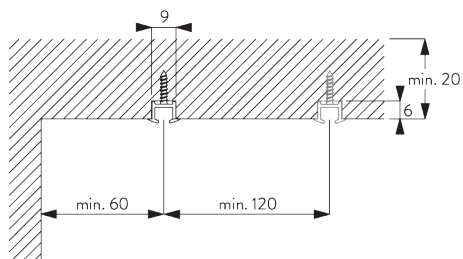

Nut Kanal: 6 x 9 mm

KOMPONENTEN

A. STANDARD KOMPONENTEN

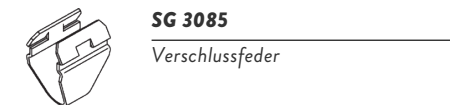
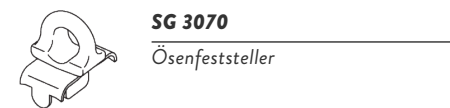
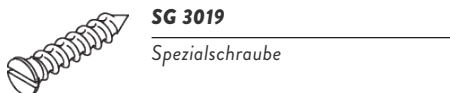
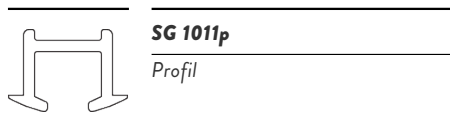

B. OPTIONALE KOMPONENTEN

