

SG 1070

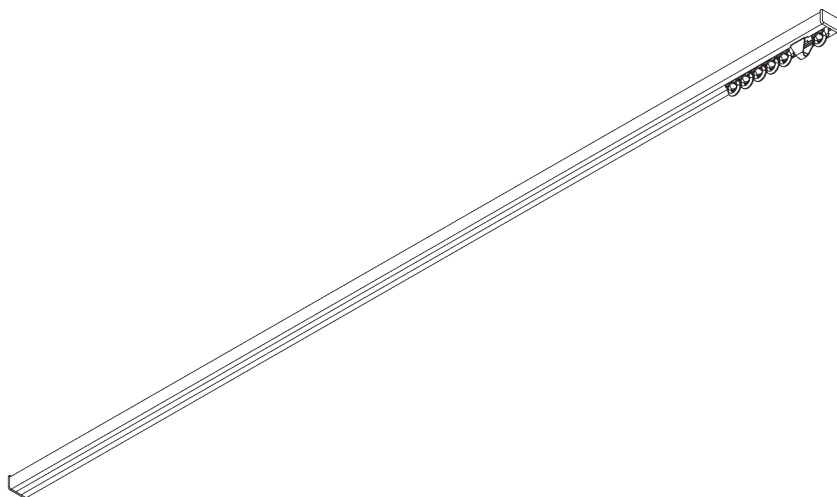

PRODUKTINFORMATIONEN

- **Bedienung:** Hand
- **Grösse:** S
- **Montage:** Decke
- **Farben:** weiss RAL 9016 oder Aluminium farblos eloxiert, Sonderfarben möglich
- **Stoffe:** siehe Silent Gliss Stoffkollektion

Merkmale:

- Biegbar

SYSTEMSPEZIFIKATIONEN

A. PROFIL

Profil- und
Biegeinformationen

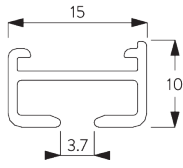

SG 1071

Profil

Radius:
8 cm, 12 cm, 16 cm,
>25 cm

B. MASSAUFNAHME

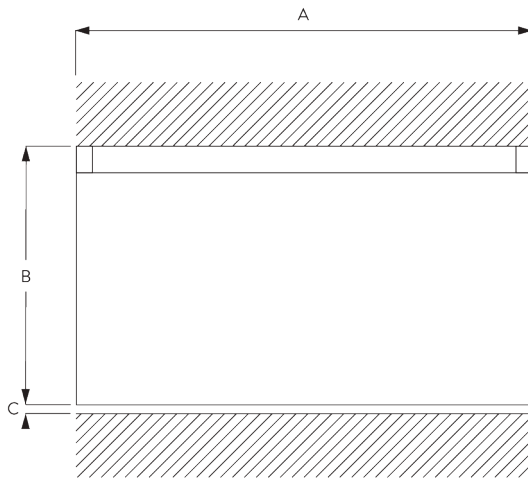

A: Systembreite

B: Systemhöhe

C: Abstand zwischen Boden und Behang

MONTAGE

A. MONTAGE- INFORMATIONEN

Detaillierte Montageinformationen siehe
Silent Gliss Website

Montagepunkte

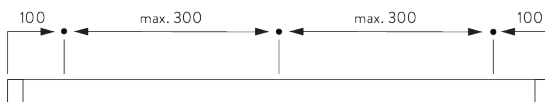

B. DECKEN- MONTAGE

Spanner SG 3060

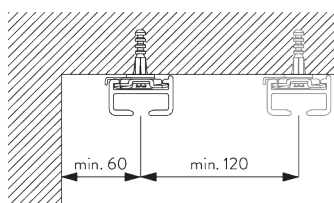

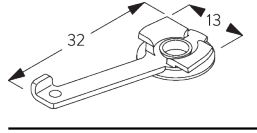

SG 3060

Spanner

ALLGEMEINE HINWEISE

Masse / Gewicht

- Massangaben in mm ausser anderweitig angegeben.
- Max. kg bezieht sich auf Stoff inklusive Zubehör.
- Paketbreite hängt von Konfektionsart und Stoffbeschaffenheit ab.
- Gleiterabstand max. 80 mm / Rollerabstand max. 100 mm.
- Empfohlener Abstand Boden / Behang: 20 mm.
- Um Systemhöhe (B) zu bestimmen muss kleinste Raumhöhe berücksichtigt werden.

Montage

- Montage nur durch Fachpersonal.
- Anzahl Träger und Montage- / Trägerpositionen sind abhängig von Montageuntergrund, Systemgewicht, Stoffkonfektion, Schrauben- / Dübeltyp sowie möglicher Hindernisse.
- Fachpersonal hat der Situation angemessene Schrauben / Dübel zu verwenden.
- Höhere Profelseite (falls vorhanden) raumseitig montieren.

Kindersicherung

- Alle relevanten Silent Gliss Systeme entsprechen der Norm EN 13120.
- Norm EN 13120 muss von allen involvierten Parteien eingehalten werden.

KOMPONENTEN

A. STANDARD KOMPONENTEN

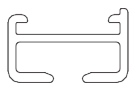

SG 1071

Profil

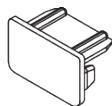

SG 1072

Enddeckel

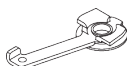

SG 3060

Spanner



SG 3070

Ösenfeststeller



SG 3085

Verschlussfeder



SG 3533

Gleiter



SG 3599

Haken

B. OPTIONALE KOMPONENTEN



SG 3012

Haken



SG 3062

Profilverbinder



SG 3511

Gleiter



SG 3534

Gleiter 3533 an der Stange



SG 3535

Gleiter



SG 3537

Gleiter



SG 3547

Clic-Gleiter

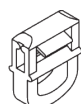

SG 3548

Gleiter



SG 3549

Klickgleiter mit Haken



SG 3582

Haken

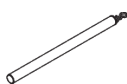

SG 10430

Schleuderstab 50 cm

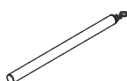

SG 10431

Schleuderstab 75 cm

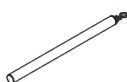

SG 10432

Schleuderstab 100 cm

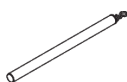

SG 10433

Schleuderstab 125 cm

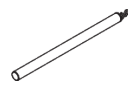

SG 10434

Schleuderstab 150 cm

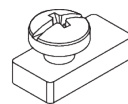

SG 11335

Feststeller