

SG 6011



PRODUKTINFORMATIONEN

- **Bedienung:** Hand
- **Grösse:** S-M
- **Montage:** Nut (Center SG 7550)
- **Farben:** weiss RAL 9016 oder Aluminium farblos eloxiert, Sonderfarben möglich
- **Stoffe:** siehe Silent Gliss Stoffkollektion

Merkmale:

- 2-Komponenten-Gleiter-Technologie (2C)
- Vorgebohrtes Profil
- Biegbar

SYSTEMSPEZIFIKATIONEN

A. PROFIL

Profil- und
Biegeinformationen

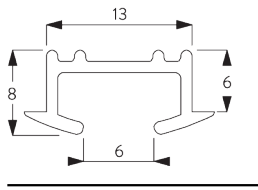

SG 6011p

Profil

Radius:
10 cm, 20 cm

B. MASSAUFNAHME

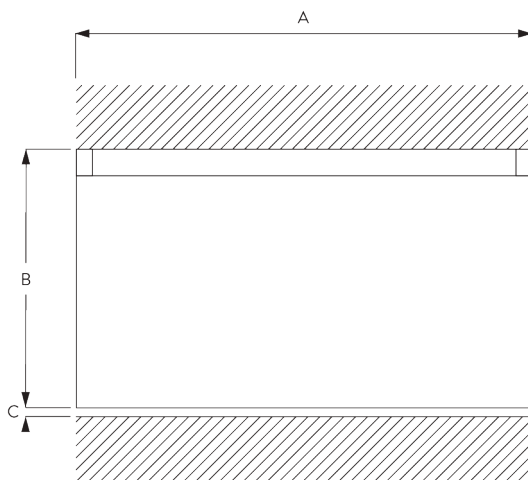

A: Systembreite

B: Systemhöhe

C: Abstand zwischen Boden und Behang

MONTAGE

A. MONTAGE- INFORMATIONEN

Detaillierte Montageinformationen siehe
Silent Gliss Website

Montagepunkte

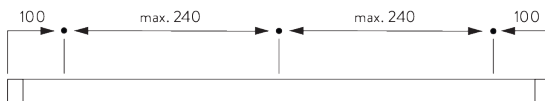

B. NUT MONTAGE

Direkt ins Holz

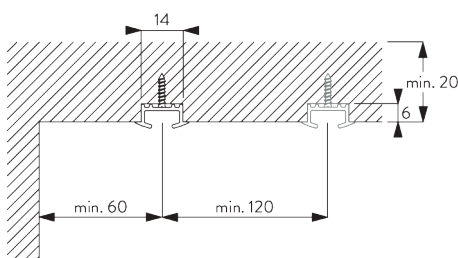

Nut Kanal: 6 x 14 mm

KOMPONENTEN

A. STANDARD KOMPONENTEN

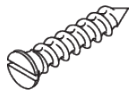

SG 3019

Speziellschraube



SG 3599

Haken

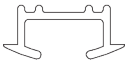

SG 6011p

Profil



SG 6015

Verschlussfeder



SG 6065

Feststeller



SG 11300

2C-Gleiter

B. OPTIONALE KOMPONENTEN



SG 3012

Haken

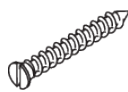

SG 3025

Speziellschraube

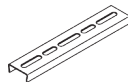

SG 3067

Profilverbinder



SG 3582

Haken



SG 3598

Öse



SG 6057

Gleiter

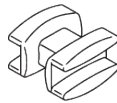

SG 6082

Gleiter

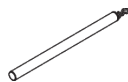

SG 10430

Schleuderstab 50 cm

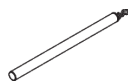

SG 10431

Schleuderstab 75 cm

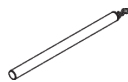

SG 10432

Schleuderstab 100 cm

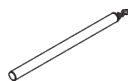

SG 10433

Schleuderstab 125 cm

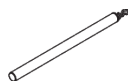

SG 10434

Schleuderstab 150 cm

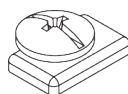

SG 11295

Feststeller



SG 11301

2C-Gleiter am Strip

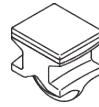

SG 11305

2C-Gleiter für direktes Annähen

