

SG 2740

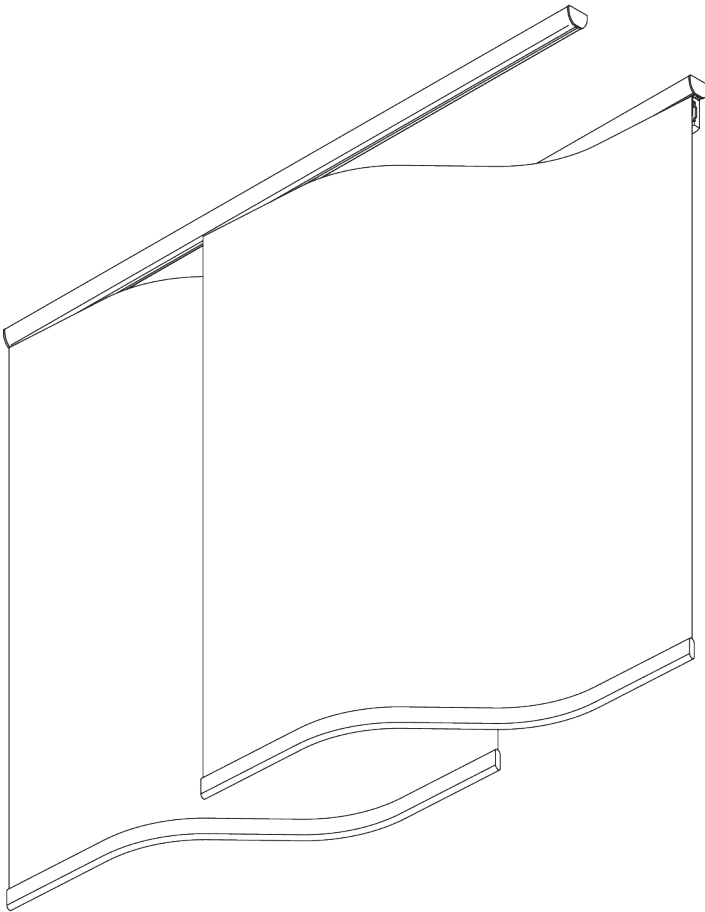

WAVE PANEL



PRODUKTINFORMATIONEN

- **Bedienung:** Hand
- **Grösse:** S - L
- **Montage:** Decke
- **Farben:** weiss RAL 9016
- **Stoffe:** siehe Silent Gliss Stoffkollektion

Merkmale:

- Wellenförmige Paneele
- Einfacher Click-In-Wagen für schnelle Montage
- Frei verschiebbare oder verbundene Paneele

SYSTEMSPEZIFIKATIONEN

A. MASSE / GEWICHT

Paneelbreite fix: 50 cm

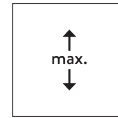
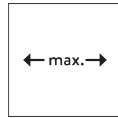
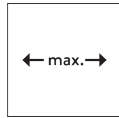

Paneele frei verschiebbar:
unlimitiert

Paneele verbunden (max.
15 Paneele): 6.05 m

2.8 m

1 kg pro Paneel
inkl. Beschwerungsprofil

Paneele frei verschiebbar

Anlagenbreite in cm	Anzahl Paneele	Vorgegebene Überlappung in cm
100 - 136	3	18.1 - 0.1
137 - 181	4	14.9 - 0.2
182 - 226	5	11.2 - 0.2
227 - 272	6	9.1 - 0.1
273 - 317	7	7.5 - 0.1
318 - 363	8	6.4 - 0.0
364 - 408	9	5.6 - 0.1
409 - 453	10	5.0 - 0.1
454 - 499	11	4.5 - 0.0
500 - 544	12	4.1 - 0.1
545 - 590	13	3.8 - 0.0
591 - 635	14	3.4 - 0.0
636 - 680	15	3.2 - 0.1

Paneele verbunden

Max. 15 verbundene
Paneele möglich!

Anlagenbreite in cm	Anzahl der Paneele	Gesamtbreite der Paneele (cm)
100 - 125	3	125
126 - 165	4	165
166 - 205	5	205
206 - 245	6	245
246 - 285	7	285
286 - 325	8	325
326 - 365	9	365
366 - 405	10	405
406 - 445	11	445
446 - 485	12	485
486 - 525	13	525
526 - 565	14	565
566 - 605	15	605

B. PROFIL

Profilinformationen

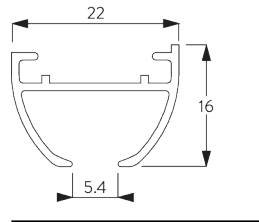

SG 6010p

Profil

C. MASSAUFNAHME

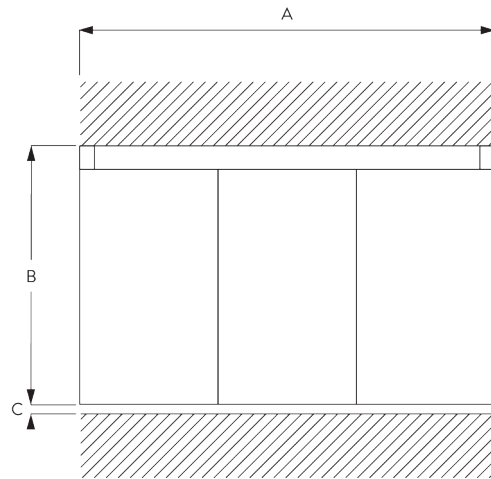

A: Systembreite

B: Systemhöhe

C: Abstand zwischen Boden und Behang

Paketbreiten

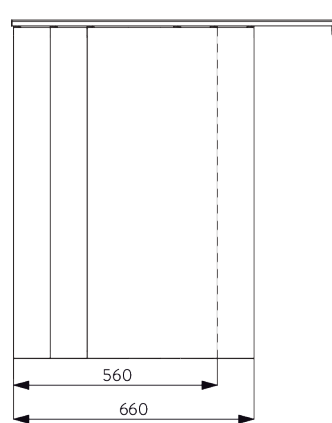

2 Paneele: 560 mm

3 Paneele: 660 mm

4 Paneele: 760 mm

5 Paneele: 860 mm

Jedes zusätzliche Paneel plus 100 mm.

Paneel Öffnung

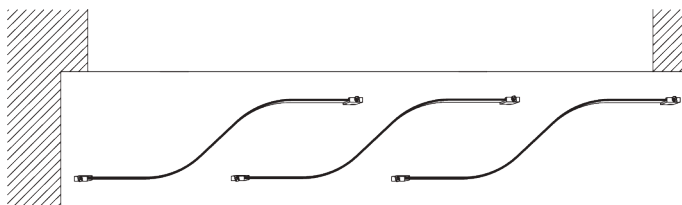

Paneelwagen A (Standard)

Öffnung zwischen den Paneelen ist nach links zum Raum.

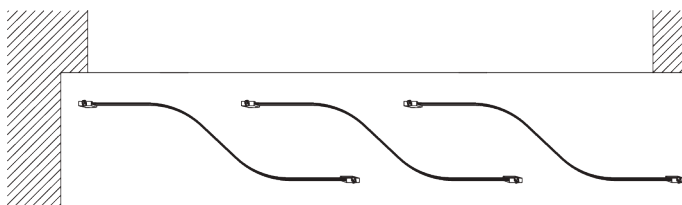

Paneelwagen B (Option)

Öffnung zwischen den Paneelen ist nach rechts zum Raum.

MONTAGE

A. MONTAGE- INFORMATIONEN

Detaillierte Montageinformationen siehe
Silent Gliss Website

Montagepunkte

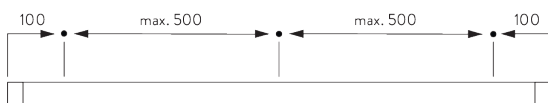

B. DECKEN- MONTAGE

Spanner SG 3825

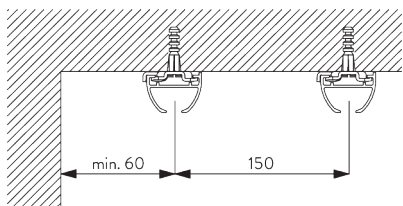

Abstand zwischen den Profilen: 15 cm

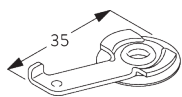

SG 3825

Spanner

KOMPONENTEN

A. STANDARD KOMPONENTEN



SG 2539

Flauschband



SG 3825

Spanner



SG 6010p

Profil

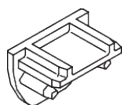

SG 6018

Enddeckel

B. OPTIONALE KOMPONENTEN

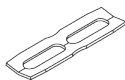

SG 3802

Profilverbinder

