

SG 4905

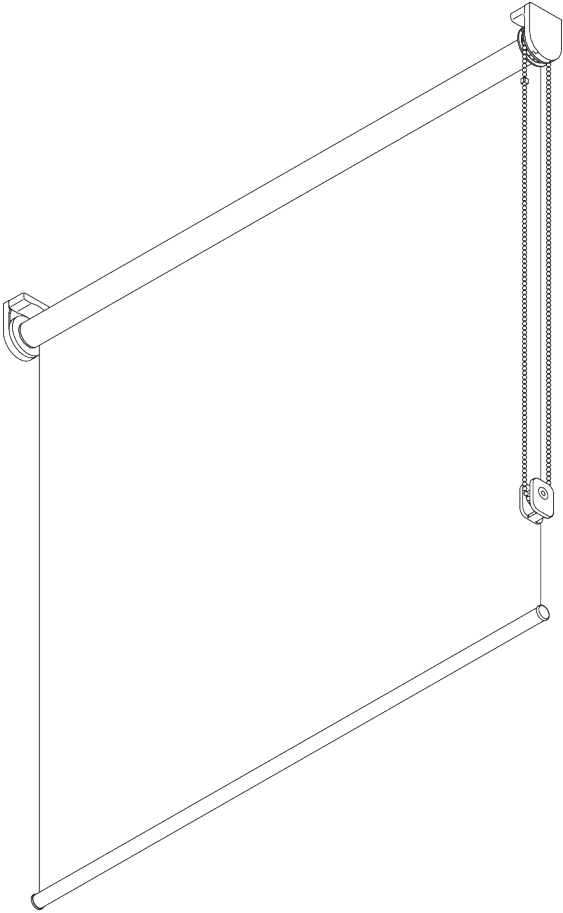

PRODUKTINFORMATIONEN

- **Bedienung:** Kette
- **Grösse:** S
- **Montage:** Decke, Wand, Nische
- **Farben:** 20 Farben plus Silber
- **Stoffe:** siehe Silent Gliss Stoffkollektion

Merkmale:

- Rostfreie Stahlkugellkette
- Klick-in-Träger

SYSTEMSPEZIFIKATIONEN

A. MASSE / GEWICHT



1.6 m



25 cm



3 m

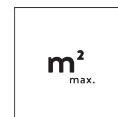

4.8 m²



1.3 kg

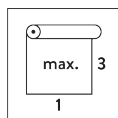

Empfohlenes Breiten- /
Höhenverhältnis
max. 1:3

Maximale Systemhöhen

Wandmontage (fensterseitig abrollend)

Stoffstärke	mm	0.15	0.20	0.25	0.30	0.35	0.40	0.45	0.50	0.55
Max. Systemhöhe	cm	300	300	300	300	290	260	240	210	190

Deckenmontage / Wandmontage (raumseitig abrollend)

Stoffstärke	mm	0.15	0.20	0.25	0.30	0.35	0.40	0.45	0.50	0.55
Max. Systemhöhe	cm	300	300	300	300	300	300	290	260	240

B. PROFIL

Profilinformationen

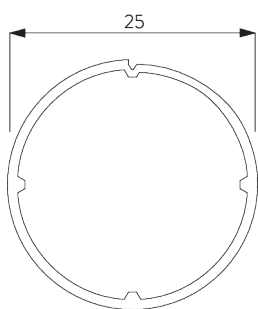

SG 10533

Rohr ø 25 mm

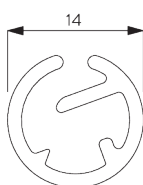

SG 10687

Beschwerungsprofil

C. MASSAUFNAHME

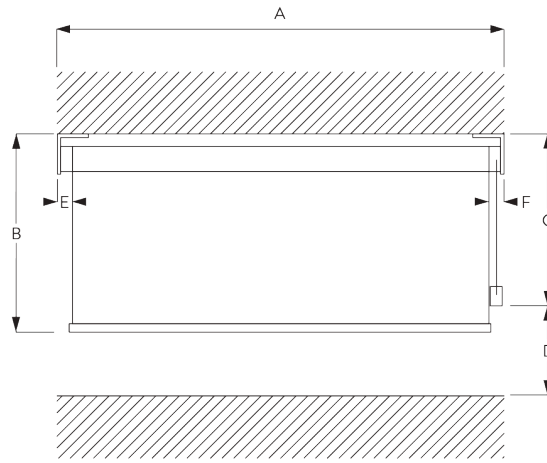

- A: Systembreite
- B: Systemhöhe
- C: Kettenhöhe
- D: Kindersicherung SG 10731 min. 150 cm über Boden
- E: Lichtspalt: 16 mm
- F: Lichtspalt Antriebsseite: 21 mm

MONTAGE

A. MONTAGE- INFORMATIONEN

Detaillierte Montageinformationen siehe
Silent Gliss Website

Montagepunkte

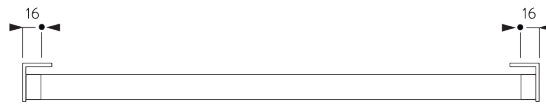

B. DECKEN- MONTAGE

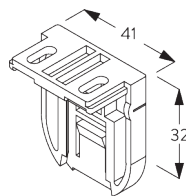
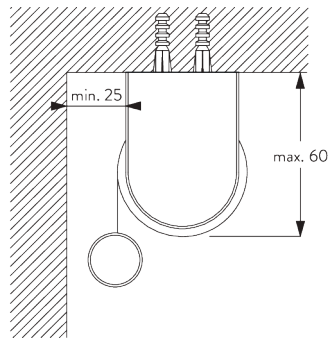

SG 10679
Träger Kettenseite

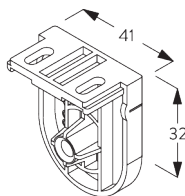

SG 10680
Träger Lagerseite

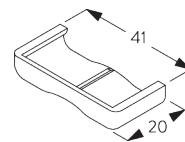

SG 10683
Trägerabdeckung

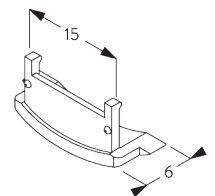

SG 10684
Trägerabdeckung

C. WANDMONTAGE

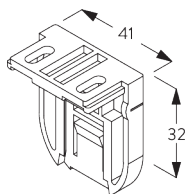
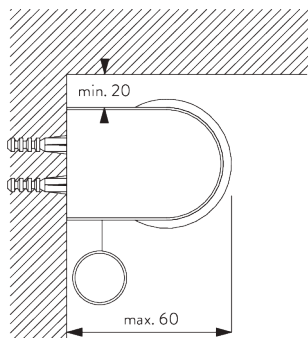

SG 10679
Träger Kettenseite

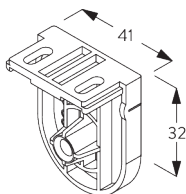

SG 10680
Träger Lagerseite

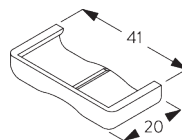

SG 10683
Trägerabdeckung

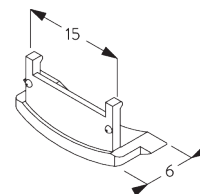

SG 10684
Trägerabdeckung

D. NISCHEN- MONTAGE

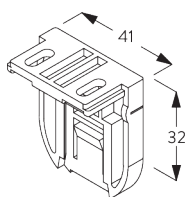
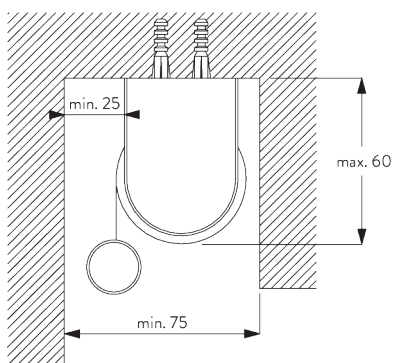

SG 10679
Träger Kettenseite

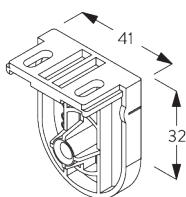

SG 10680
Träger Lagerseite

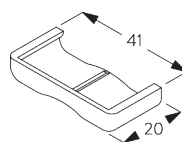

SG 10683
Trägerabdeckung

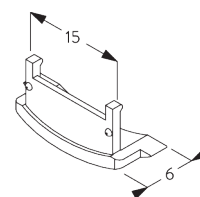

SG 10684
Trägerabdeckung

**E. SEITLICHE
VERSpannung**

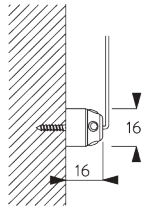
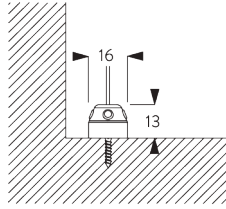

Einzelsystem

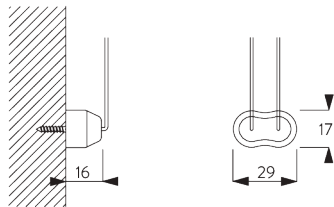
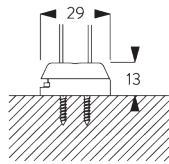

Seite-an-Seite Montage

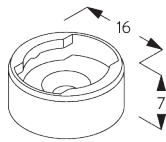

SG 8235
Halter Seitenführung kurz

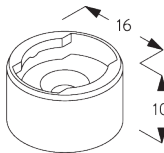

SG 8236
Halter Seitenführung lang

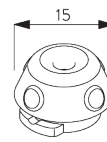

SG 8237
Halter Seitenführung

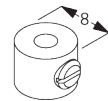

SG 8249
Stellingring Seitenführung

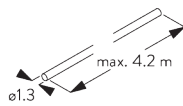

SG 10643
Draht Seitenführung Ø 1.3
mm x 4.2 m

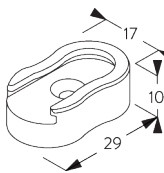

SG 10669
Doppelhalter lang
Seitenführung lang

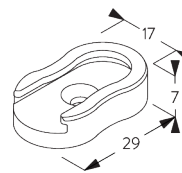

SG 10673
Doppelhalter kurz
Seitenführung kurz

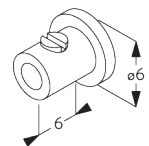

SG 10676
Stellingring

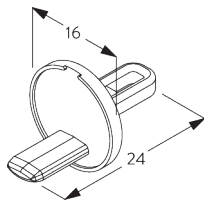

SG 10686

Enddeckel rund mit Öse

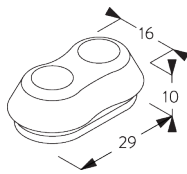

SG 10701

Doppelhalter Seitenführung

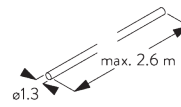

SG 10706

Draht Seitenführung \varnothing 1.3 mm
x 2.6 m

SYSTEMOPTIONEN

A. ABROLL- RICHTUNG

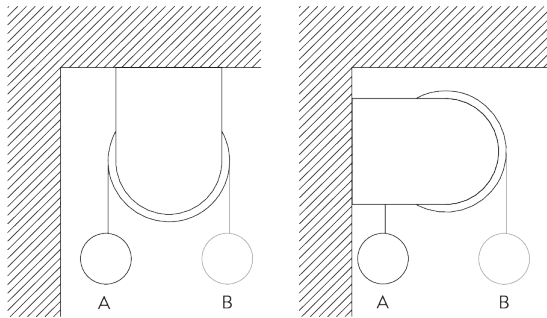

A: Fensterseitiges Stoffabrollen (Standard)

B: Raumseitiges Stoffabrollen (Option)

B. SEITLICHE VERSpannung

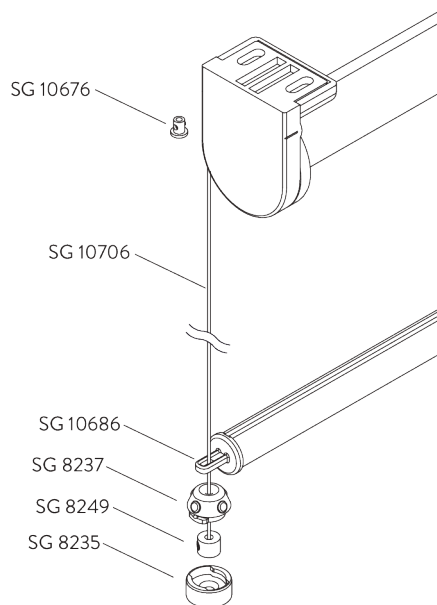

Zubehör:

- 2x SG 8235 Halter Seitenführung kurz
- 2x SG 8237 Halter Seitenführung
- 2x SG 8249 Stelling Seitenführung
- 2x SG 10676 Stelling
- 2x SG 10686 Enddeckel Seitenführung
- 2x SG 10706 Draht Seitenführung \varnothing 1.3 mm x 2.6 m

Optionales Zubehör:

- 2x SG 8236 Halter Seitenführung lang
- 2x SG 10643 Draht Seitenführung \varnothing 1.3 mm x 4.2 m
- 1x SG 10669 Doppelhalter lang Seitenführung
- 1x SG 10673 Doppelhalter kurz Seitenführung
- 1x SG 10701 Doppelhalter Seitenführung

Bemerkung:

- Bei Verspannung vergrößert sich der Lichtspalt
- Bis 15° Neigung von der Vertikalen

**C. KINDER-
SICHERUNG**

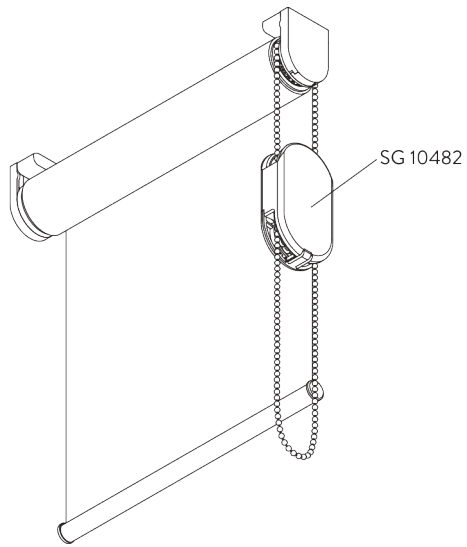

Die Kindersicherung SG 10482 öffnet sich bei 6 kg Zugbelastung.

Bemerkung:
Die Kettenschleife muss mindestens 60 cm über dem Boden enden.

KOMPONENTEN

A. STANDARD KOMPONENTEN



SG 4187

Plastikkeder

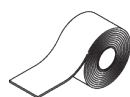

SG 4226

Doppelklebeband 30 mm



SG 10530

Kugelmutterkette Ø 4 mm Stahl rostfrei

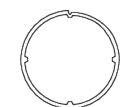

SG 10533

Rohr ø 25 mm

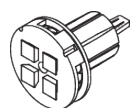

SG 10670

Kettenantrieb bis 1.2 kg
Stoffgewicht

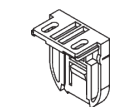

SG 10679

Träger Kettenseite

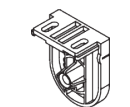

SG 10680

Träger Lagerseite

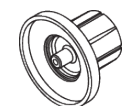

SG 10681

Rohradapter

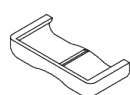

SG 10683

Trägerabdeckung

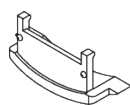

SG 10684

Trägerabdeckung



SG 10685

Enddeckel rund



SG 10687

Beschwerungsprofil



SG 10731

Kindersicherheitshalterset

B. OPTIONALE KOMPONENTEN



SG 8235

Halter Seitenführung kurz



SG 8236

Halter Seitenführung lang



SG 8237

Halter Seitenführung

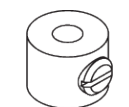

SG 8249

Stelling Seitenführung

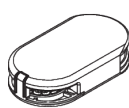

SG 10482

Kindersicherheitsset Stahlkette ø 4.0
mm

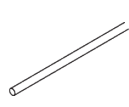

SG 10643

Draht Seitenführung Ø 1.3 mm x
4.2 m



SG 10669

Doppelhalter lang Seitenführung
lang



SG 10673

Doppelhalter kurz Seitenführung
kurz



SG 10676

Stelling



SG 10686

Enddeckel rund mit Öse



SG 10701

Doppelhalter Seitenführung

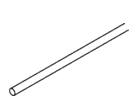

SG 10706

Draht Seitenführung ø 1.3 mm x 2.6
m

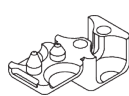

SG 10709

Kugelmutterstopper

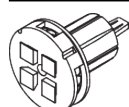

SG 10710

Kettenantrieb bis 0.5 kg
Stoffgewicht