

# SG 4960

---

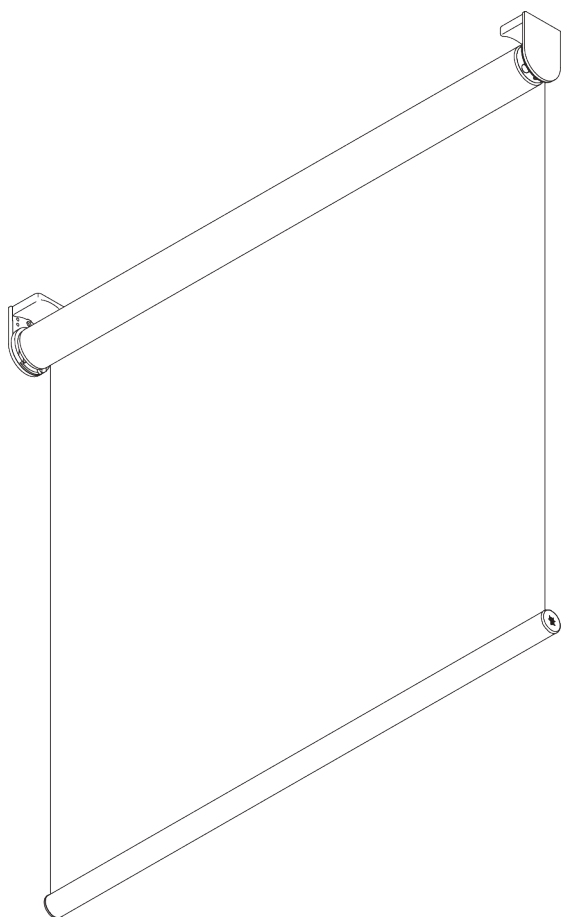
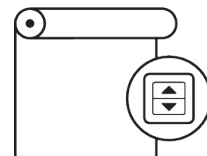

## PRODUKTINFORMATIONEN

- **Bedienung:** Motor
- **Grösse:** S - M
- **Montage:** Decke, Wand, Nische
- **Farben:** weiss RAL 9016, grau RAL 7035, schwarz RAL 9005; Sonderfarben möglich
- **Stoffe:** siehe Silent Gliss Stoffkollektion

### **Merkmale:**

- Leise und schnelle Motoren, Soft-Stop
- Vielfältige Steuerungsmöglichkeiten
- Zwei gekoppelte Systeme
- Klick-in Träger
- Fascia, Box, Montageprofil

01/2025/V1

# SYSTEMSPEZIFIKATIONEN

## A. MASSE / GEWICHT

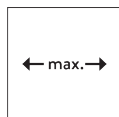

*Einzelsystem: 2.4 m*  
*Gekoppelte Systeme:*  
*4.8 m*

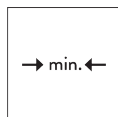

*61 cm\**  
*\*siehe*  
*Motorspezifikationstabelle*

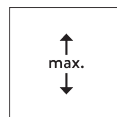

*4 m*

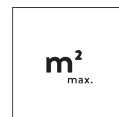

*Einzelsystem: 9.6 m²*  
*Gekoppelte Systeme:*  
*19.2 m²*



*5.5 kg*

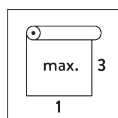

*Empfohlenes Breiten- /*  
*Höhenverhältnis*  
*max. 1:3*

## Maximale Systemhöhe

### Wandmontage (fensterseitig abrollend)

Stoffdicke	mm	0.15	0.20	0.25	0.30	0.35	0.40	0.45	0.50	0.55	0.60	0.65	0.70	0.75	0.80
Max. Systemhöhe	cm	400	400	400	400	400	400	390	350	320	290	270	250	230	220

### Deckenmontage / Wandmontage (raumseitig abrollend)

Stoffdicke	mm	0.15	0.20	0.25	0.30	0.35	0.40	0.45	0.50	0.55	0.60	0.65	0.70	0.75	0.80
Max. Systemhöhe	cm	400	400	400	400	400	400	400	400	400	380	350	330	300	280

## B. PROFIL

### Profilinformationen

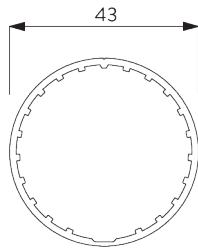

**SG 10532**  
Rohr  $\varnothing$  43 mm



**SG 10760**  
Beschwerung

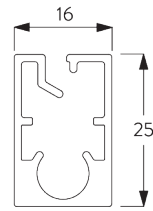

**SG 10770**  
Beschwerung

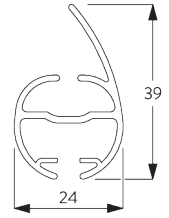

**SG 4903**  
Beschwerung

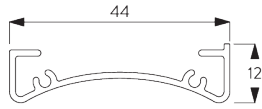

**SG 10534**  
Montageprofil

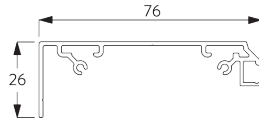

**SG 11430**  
Montageprofil Fascia 73 mm

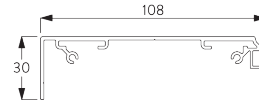

**SG 11530**  
Montageprofil Fascia 110 mm

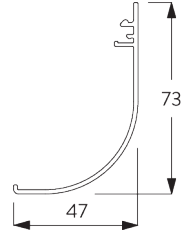

**SG 11431**  
Fascia rund 73 mm

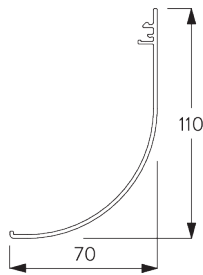

**SG 11531**  
Fascia rund 110 mm

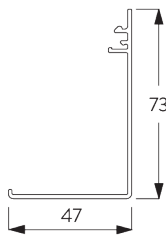

**SG 11432**  
Fascia eckig 73 mm

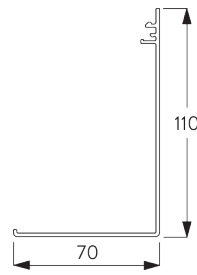

**SG 11532**  
Fascia eckig 110 mm

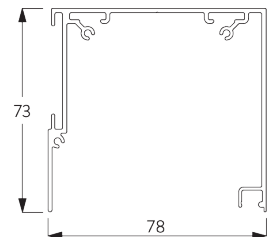

**SG 11433**  
Box 73 mm

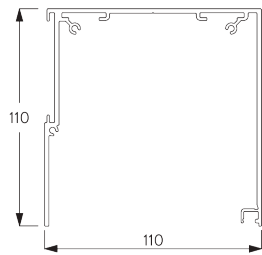

**SG 11533**  
Box 110 mm

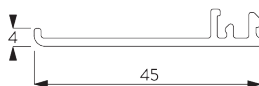

**SG 11434**  
Box Deckel 73 mm

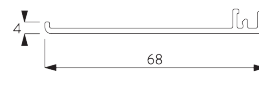

**SG 11534**  
Box Deckel 110 mm

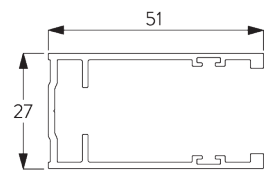

**SG 11542**  
Seitliche Führungsschiene

## C. MASSAUFNAHME

inkl. Trägerabdeckung

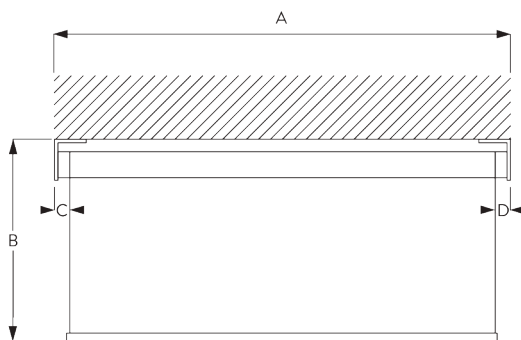

A: Systembreite  
B: Systemhöhe  
C: Lichtspalt: 13 mm  
D: Lichtspalt Antriebsseite: 19 mm

Bemerkung:  
Unterschiedliche Lichtspalte siehe Motorenspezifikationen.  
Alle Masse beinhalten 2 mm für die Trägerabdeckung pro Seite!



## Fascia / Box

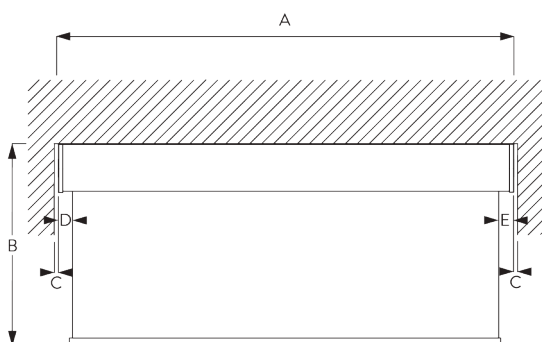

A: Systembreite  
B: Systemhöhe  
C: Spalt: min. 10 mm (wenn Abdeckung verwendet wird)\*  
D: Lichtspalt: 15 mm  
E: Lichtspalt Antriebsseite: 21 mm

Bemerkung:  
Unterschiedliche Lichtspalte siehe Motorenspezifikationen.  
\*Es ist möglich, die Fascia breiter als das System zu machen, um den Abstand zwischen Wand und System zu verringern.



## Fascia / Box mit seitlichen Führungsschienen SG 11542

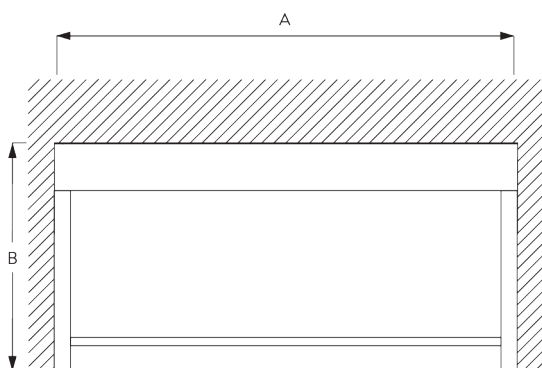

A: Systembreite  
B: Systemhöhe

# MONTAGE

## A. MONTAGE- INFORMATIONEN

Detaillierte Montageinformationen siehe  
Silent Gliss Website.

## Montagepunkte



Träger (Wand / Decke)

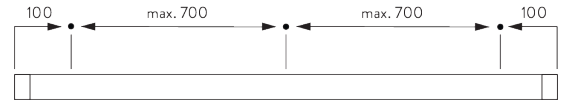

Fascia / Box & Montageprofil SG 10534 (Wand / Decke)

## B. DECKEN- MONTAGE

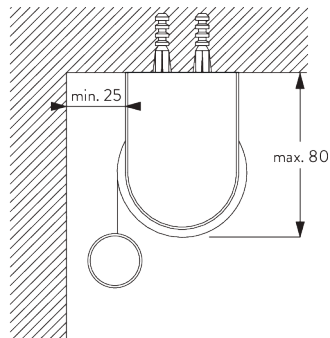

Träger

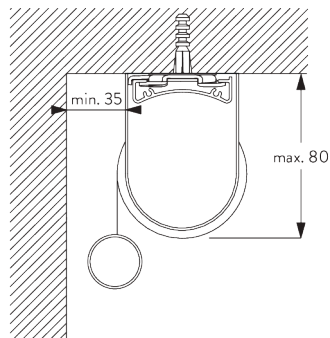

Montageprofil SG 10534 und Spanner SG 3033  
oder SG 3044

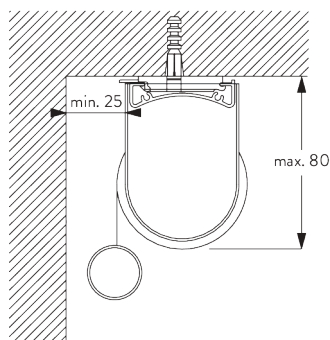

Montageprofil SG 10534 und Klick-Träger SG 10539  
Nicht möglich mit gekoppelten Systemen.

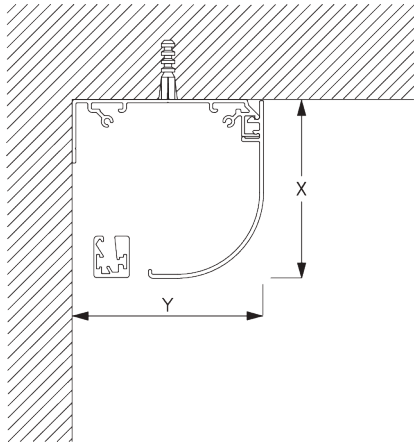

**Fascia rund**

X = Fascia S 73 mm / Fascia L 110 mm

Y = Fascia S 78 mm / Fascia L 110 mm

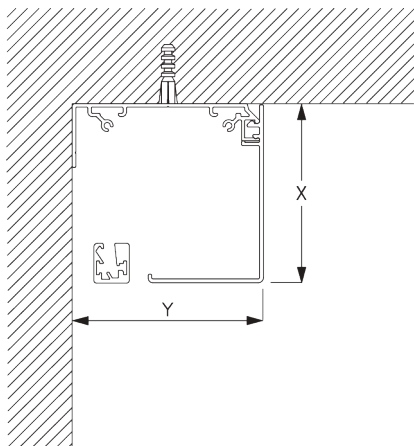

**Fascia eckig**

X = Fascia S 73 mm / Fascia L 110 mm

Y = Fascia S 78 mm / Fascia L 110 mm

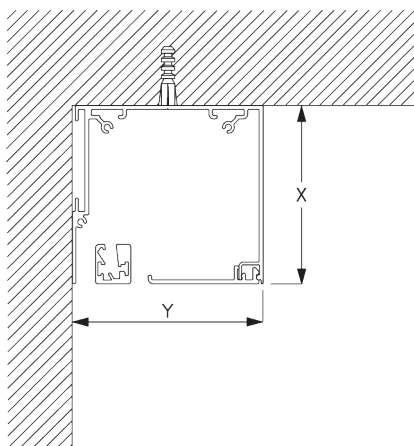

**Box**

X = Box S 73 mm / Box L 110 mm

Y = Box S 78 mm / Box L 110 mm

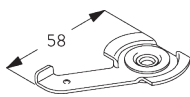

**SG 3033**  
Spanner

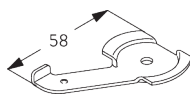

**SG 3044**  
Spanner

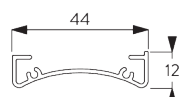

**SG 10534**  
Montageprofil

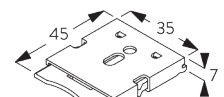

**SG 10539**  
Klickträger

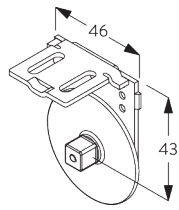

**SG 10542**  
Träger

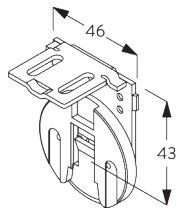

**SG 10543**  
Träger



**SG 10574**  
Trägerabdeckung

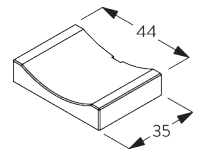

**SG 10575**  
Trägerabdeckung

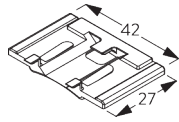

**SG 10690**  
Distanzhalter

## C. WANDMONTAGE

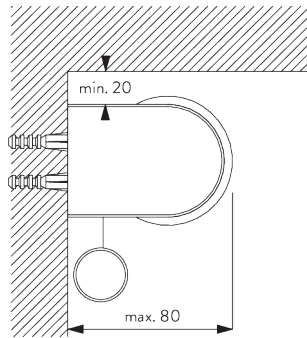

**Träger**

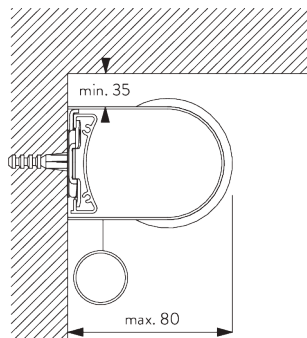

**Montageprofil SG 10534 und Spanner SG 3033  
oder SG 3044**

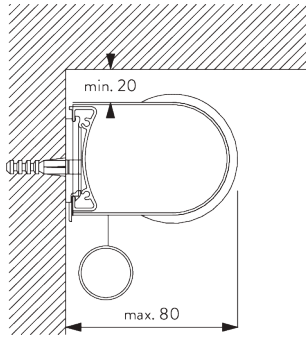

**Montageprofil SG 10534 und Klick-Träger SG 10539**  
 Nicht möglich mit gekoppelten Systemen.

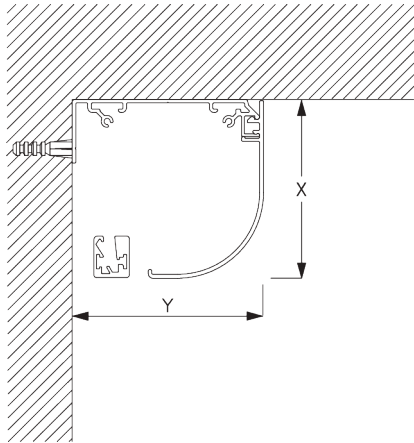

**Fascia rund**  
 X = Fascia S 73 mm / Fascia L 110 mm  
 Y = Fascia S 78 mm / Fascia L 110 mm

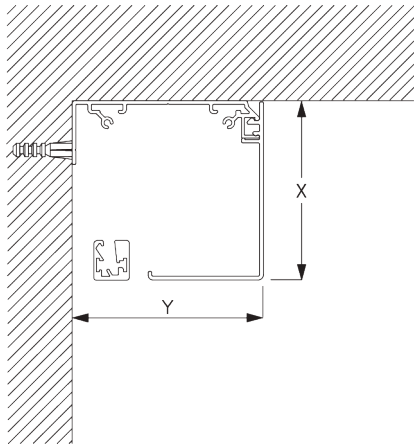

**Fascia eckig**  
 X = Fascia S 73 mm / Fascia L 110 mm  
 Y = Fascia S 78 mm / Fascia L 110 mm



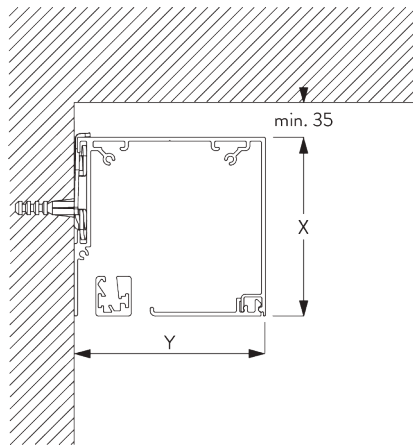

**Box S und Spanner SG 3044 / Box L und Spanner SG 11180**

X = Box S 73 mm / Box L 110 mm

Y = Box S 78 mm / Box L 110 mm

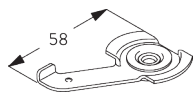

**SG 3033**  
Spanner

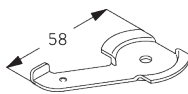

**SG 3044**  
Spanner

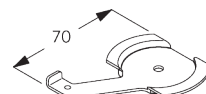

**SG 11180**  
Spanner

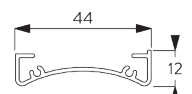

**SG 10534**  
Montageprofil

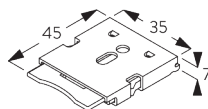

**SG 10539**  
Klickträger

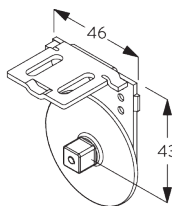

**SG 10542**  
Träger

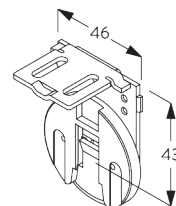

**SG 10543**  
Träger

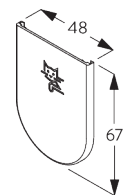

**SG 10574**  
Trägerabdeckung

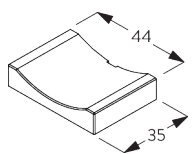

**SG 10575**  
Trägerabdeckung

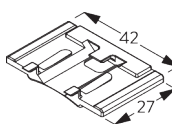

**SG 10690**  
Distanzhalter

**D. NISCHEN-  
MONTAGE**

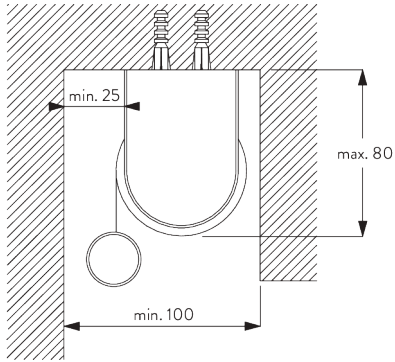

**Träger**

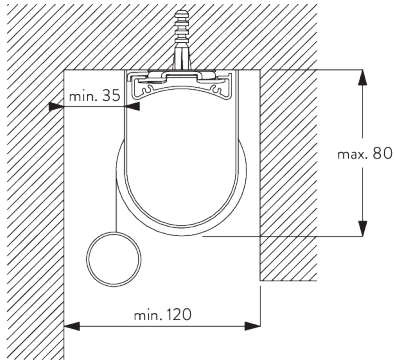

**Montageprofil SG 10534 und Spanner SG 3033  
oder SG 3044**

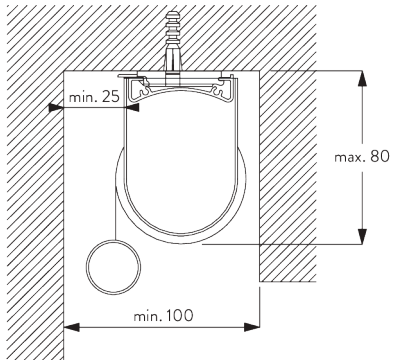

**Montageprofil SG 10534 und Klick-Träger SG 10539**  
Nicht möglich mit gekoppelten Systemen.

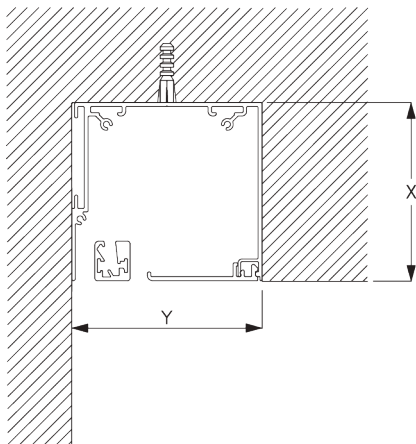

**Box**  
X = Box S 73 mm / Box L 110 mm  
Y = Box S min. 79 mm / Box L min. 111 mm

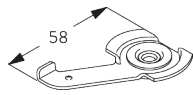

**SG 3033**  
Spanner

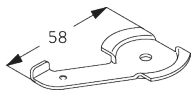

**SG 3044**  
Spanner

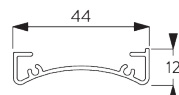

**SG 10534**  
Montageprofil

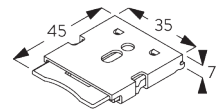

**SG 10539**  
Klickträger

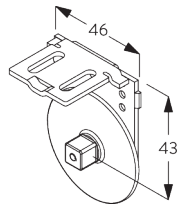

**SG 10542**  
Träger

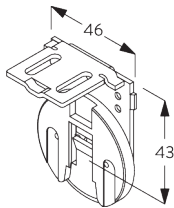

**SG 10543**  
Träger

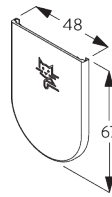

**SG 10574**  
Trägerabdeckung

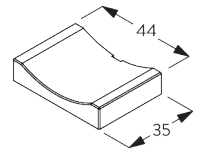

**SG 10575**  
Trägerabdeckung

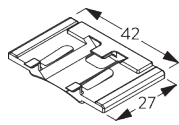

**SG 10690**  
Distanzhalter

**E. SEITLICHE  
VERSPANNUNG**

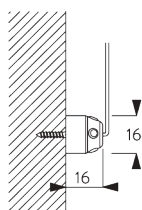
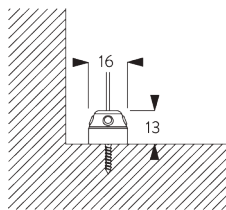

**Einzelsystem**

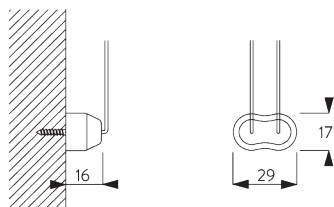
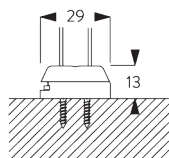

**Gekoppeltes System (Seite-an-Seite-Montage)**

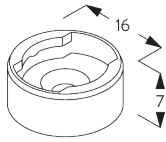

**SG 8235**  
Halter Seitenführung kurz

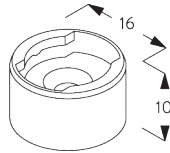

**SG 8236**  
Halter Seitenführung lang

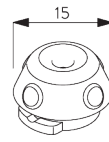

**SG 8237**  
Halter Seitenführung

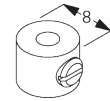

**SG 8249**  
Stellingring Seitenführung

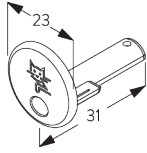

**SG 10762**  
Enddeckel Seitenführung

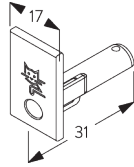

**SG 10772**  
Enddeckel Seitenführung

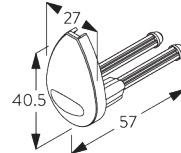

**SG 4944**  
Enddeckel

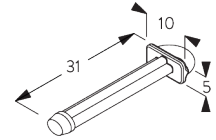

**SG 10641**  
Öse Seitenführung

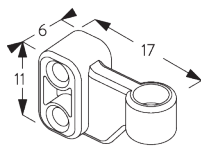

**SG 10642**  
Drahthalter Seitenführung

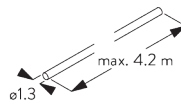

**SG 10643**  
Draht Seitenführung Ø 1.3 mm x 4.2 m

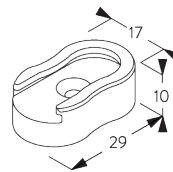

**SG 10669**  
Doppelhalter lang  
Seitenführung lang

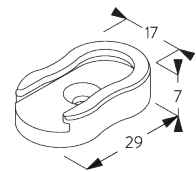

**SG 10673**  
Doppelhalter kurz  
Seitenführung kurz

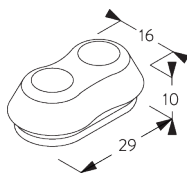

**SG 10701**  
Doppelhalter Seitenführung

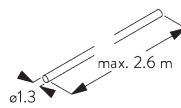

**SG 10706**  
Draht Seitenführung ø 1.3 mm x 2.6 m

## SYSTEMOPTIONEN

### A. ABROLL- RICHTUNG

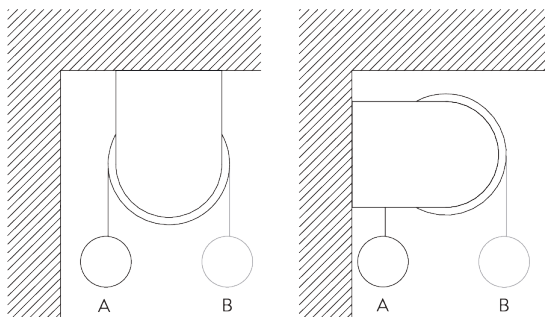

A: Fensterseitiges Stoffabrollen (Standard)  
B: Raumseitiges Stoffabrollen (Option)

## B. MONTAGEPROFIL

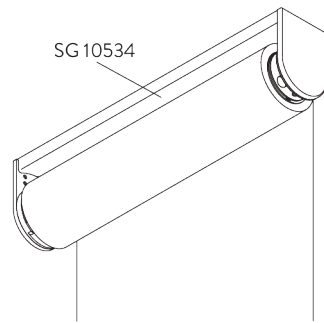

## C. SEITLICHE VERSpannung

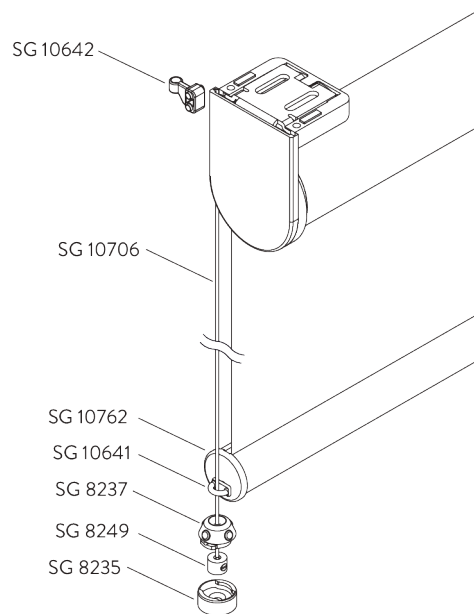

### Zubehör:

- 2x SG 8235 Halter Seitenführung kurz
- 2x SG 8237 Halter Seitenführung
- 2x SG 8249 Stelling Seitenführung
- 2x SG 10762 Enddeckel rund Seitenführung
- 2x SG 10641 Öse Seitenführung
- 2x SG 10642 Drahthalter Seitenführung
- 2x SG 10706 Draht Seitenführung  $\varnothing$  1.3 mm x 2.6 m

### Optionales Zubehör:

- 2x SG 8236 Halter Seitenführung lang
- 2x SG 10772 Enddeckel rechteckig Seitenführung
- 2x SG 10643 Draht Seitenführung  $\varnothing$  1.3 mm x 4.2 m
- 1x SG 10669 Doppelhalter lang Seitenführung
- 1x SG 10673 Doppelhalter kurz Seitenführung
- 1x SG 10701 Doppelhalter Seitenführung

### Bemerkung:

- Bei Verspannung vergrößert sich der Lichtspalt
- Bis 15° Neigung von der Vertikalen

## D. ZWEI GEKOPPELTE SYSTEME

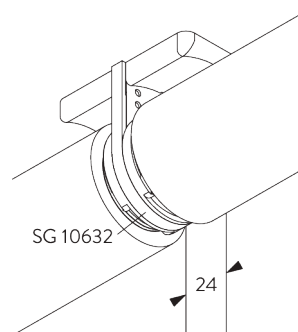

### Zubehör:

- 1x SG 10558 Zwischenverbinder
- 2x SG 10626 Zwischenträger
- 2x SG 10627 Zwischenflansche
- 1x SG 10628 Adapter für Zwischenverbinder
- 1x SG 10632 Zwischenabdeckung

### Bemerkung:

- Mit 24 V Motor SG 10692 nicht möglich!

**E. SEITE-AN-SEITE**  
**MONTAGE**

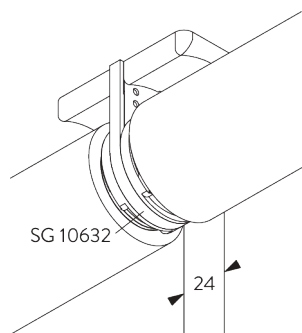

Zubehör:

- 1x SG 10632 Zwischenabdeckung

**F. FASCIA / BOX**

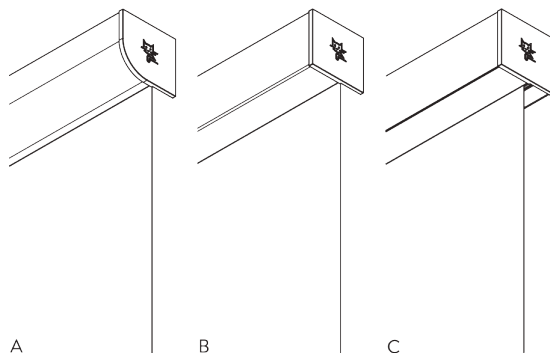

A: Fascia rund

B: Fascia eckig

C: Box

Größen:

- S: 78 x 73 mm
- L: 110 x 110 mm

Bemerkung:

- Nur anwendbar mit Beschwerung SG 11442
- Nicht möglich mit gekoppelten Systemen
- Zwei Systeme mit einer Fascia möglich auf Anfrage

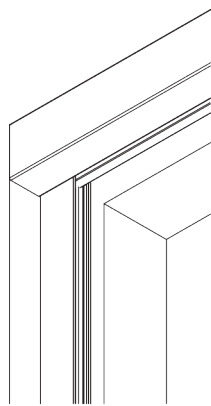

Optionale seitliche Führungsschienen SG 11542 zur Verwendung mit Fascia oder Box.

Bemerkung:

- Nur möglich mit Untermontage
- Box: nur Nischenmontage

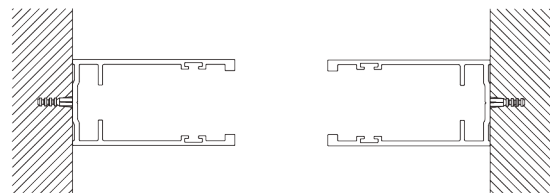

# MOTOREN UND BEDIENUNGSARTEN

## A. MOTOREN- MERKMALE

Motoren	50-Serie	20-Serie	20-Serie	10-Serie K	5-Serie	24 V DC
	SG 11250	SG 10321	SG 10320	SG 10514	SG 10715	SG 10692

### Motoreigenschaften

Soft-Stop	•	•	•			
Elektronische Endposition	•	•	•			•
Elektronischer Umdrehungszähler (Umdrehungszahl unbegrenzt)	•	•	•			•
Mechanische Endposition				•	•	
Mechanischer Umdrehungszähler (Umdrehungszahl begrenzt)				•	•	
Zwei Zwischenpositionen möglich		•				
Ausrichtung der Beschwerungsprofile	•					
Geräuschloser Stopp		•	•	•		•
Parallelschaltung möglich ohne zusätzliche Relais		•	•			
Anschlusskabel an Motor ansteckbar	•	•	•			
IP Klasse	IP 30	IP 44	IP 44	IP 44	IP 44	IP 30

### Steuerungsmöglichkeiten

Netzstrom		•	•	•	•	
Potenzialfreie Kontakte						•
SG Control L (eingebauter Funkempfänger)		•				
Smart by Silent Gliss	•					
Geeignet für alle gängigen Hausautomationssysteme (mit passender Schnittstelle)		•	•	•	•	•

## B. MOTOREN- SPEZIFIKATIONEN

Siehe Website für  
Schaltschema.

Motoren	Lichtspalte* C / D = Antriebsseite	Min. System- breite	Spannung	Stromstärke	Frequenz	Drehzahl	Funkfrequenz Empfänger
<b>50-Serie (Smart by Silent Gliss)</b>							
SG 11250	C: 10 mm / D: 26 mm	61 cm	24 V DC	1.8 A	-	55 rpm	-
<b>20-Serie</b>							
SG 10320 (Standard)	C: 13 mm / D: 19 mm	61 cm	230 V AC	0.55 A	50 Hz	70 U/Min	-
SG 10321	C: 13 mm / D: 19 mm	61 cm	230 V AC	0.55 A	50 Hz	70 U/Min	868/915 MHz
<b>10-Serie K</b>							
SG 10514	C: 10 mm / D: 25 mm	50 cm	230 V AC	0.52 A	50 Hz	30 U/Min	-
<b>5-Serie</b>							
SG 10715	C: 10 mm / D: 25 mm	61 cm	230 V AC	0.485 A	50-60 Hz	28 U/Min	-
<b>24 V DC</b>							
SG 10692	C: 13 mm / D: 19 mm	50 cm	24 V DC	0.7 A	-	25 U/Min	-

\*Lichtspalte Fascia oder Box: C +2 mm / D +2 mm

## C. BEDIENUNGS- ARTEN

Siehe Katalog "Steuerungen" für mehr Details.

**Wandschalter**



*Bedienbar mit drahtgebundenem Wandschalter.*

**SG Control L**



*Verschiedene Funkfernsteuerungen erhältlich.*



*Silent Gliss Move App.*

**Smart by Silent Gliss**



*Offenes Zwei-Weg-Kommunikationssystem, das eine problemlose Integration der Produkte mit den meisten gängigen Gebäudemanagementsystemen ermöglicht.*

**D. SCHALTSCHEMA**



*Siehe Silent Gliss Website.*



# KOMPONENTEN

## A. STANDARD KOMPONENTEN

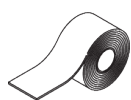

**SG 4226**

Doppelklebeband 30 mm

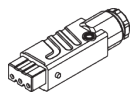

**SG 9917**

Hirschmann Kupplung STAK 3 N



**SG 10284**

O-Ring ø12.1x2.7



**SG 10320**

Motor 230V AC, 20er Serie S 1.5/70

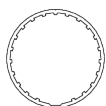

**SG 10532**

Rohr ø 43 mm

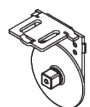

**SG 10542**

Träger

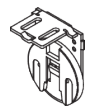

**SG 10543**

Träger



**SG 10557**

Lager



**SG 10574**

Trägerabdeckung

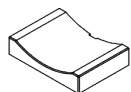

**SG 10575**

Trägerabdeckung

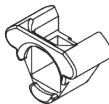

**SG 10620**

Motorenflansch 10/20-Serie



**SG 10621**

Rohradapter

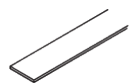

**SG 10668**

PVC Streifen 10 mm



**SG 10760**

Beschwerung



**SG 10761**

Enddeckel

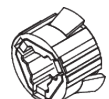

**SG 11354**

Mitnehmerset 10/20-Serie



**SG 3033**

Spanner



**SG 3044**

Spanner

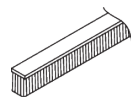

**SG 4508**

Bürste 5x7 mm



**SG 4903**

Beschwerung



**SG 8235**

Halter Seitenführung kurz

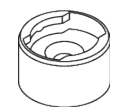

**SG 8236**

Halter Seitenführung lang

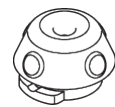

**SG 8237**

Halter Seitenführung

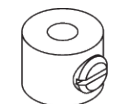

**SG 8249**

Stellring Seitenführung

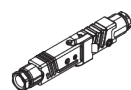

**SG 9916**

Hirschmann Kupplungsset

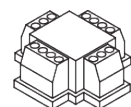

**SG 9959**

Trennrelais

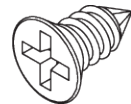

**SG 10139**

Senkschraube 2.9x6.5

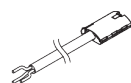

**SG 10293**

Anschlusskabel 230V AC, 2/3/5/10 m







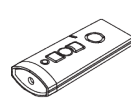





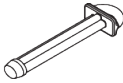



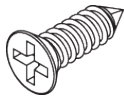

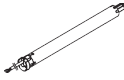

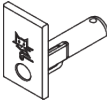







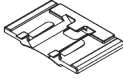

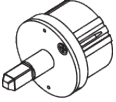





**SG 10300**

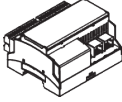
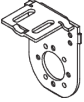

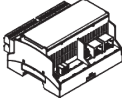

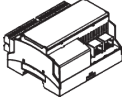

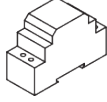

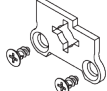
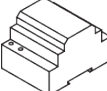

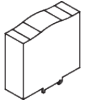

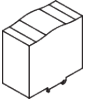

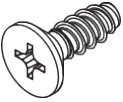

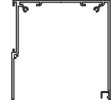
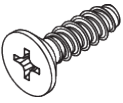

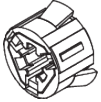
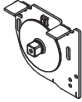

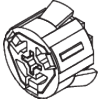

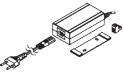

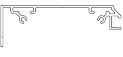



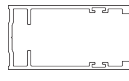



Funkhandsender 1-Kanal



**SG 10302**

Funkhandsender 5+1-Kanal

	<b>SG 10303</b> Funkhandsender 10+2+1-Kanal		<b>SG 10641</b> Öse Seitenführung		<b>SG 10762</b> Enddeckel Seitenführung
	<b>SG 10321</b> Motor 230V AC, 20er Serie S 1.5/70, Funkempfänger		<b>SG 10642</b> Drahthalter Seitenführung		<b>SG 10770</b> Beschwerung
	<b>SG 10498</b> Senkschraube 2.9x9.5		<b>SG 10643</b> Draht Seitenführung Ø 1.3 mm x 4.2 m		<b>SG 10771</b> Enddeckel
	<b>SG 10514</b> Motor 230V AC, 10er Serie S 3/30 K		<b>SG 10651</b> Zwischenflansch mit Ring		<b>SG 10772</b> Enddeckel Seitenführung
	<b>SG 10534</b> Montageprofil		<b>SG 10669</b> Doppelhalter lang Seitenführung lang		<b>SG 10804</b> Funkhandsender 15+5+1 Kanal
	<b>SG 10539</b> Klickträger		<b>SG 10673</b> Doppelhalter kurz Seitenführung kurz		<b>SG 11178</b> Enddeckel
	<b>SG 10544</b> Träger		<b>SG 10690</b> Distanzhalter		<b>SG 11180</b> Spanner
	<b>SG 10558</b> Rohrverbinder		<b>SG 10692</b> Motor 24 V DC, 2/38		<b>SG 11250</b> Motor 24V DC, 50-Series S 1.5/55
	<b>SG 10622</b> Rohradapter 24V DC Motor		<b>SG 10701</b> Doppelhalter Seitenführung		<b>SG 11258</b> Lagergehäuse
	<b>SG 10625</b> Motor Flansche weiß (10-/20-Serie Motor)		<b>SG 10706</b> Draht Seitenführung ø 1.3 mm x 2.6 m		<b>SG 11260</b> Gateway Cedia
	<b>SG 10626</b> Verbindungsträger		<b>SG 10708</b> Adapterset 24V DC		<b>SG 11261</b> Gateway KNX
	<b>SG 10627</b> Verbindungsflansch		<b>SG 10715</b> Motor 230V AC, 5er Serie S 6/28		<b>SG 11262</b> Erweiterung
	<b>SG 10628</b> Adapter Verbindungsträger		<b>SG 10747</b> Motorenplatte S		<b>SG 11263</b> Transformer 24V DC, 2.5 Ampere DIN Rail
	<b>SG 10632</b> Abdeckung Verbindungsträger		<b>SG 10753</b> Motorenplatte		<b>SG 11264</b> Transformer 24V DC, 3.8 Ampere DIN Rail

	<b>SG 11265</b> Transformer 24V DC, 5 Ampere DIN Rail		<b>SG 11439</b> Trägerabdeckung eckig links 73 mm		<b>SG 11531</b> Fascia rund 110 mm
	<b>SG 11266</b> Transformer 24V DC, 10 Ampere DIN Rail		<b>SG 11440</b> Trägerabdeckung eckig rechts 73 mm		<b>SG 11532</b> Fascia eckig 110 mm
	<b>SG 11322</b> PT Schraube Senkkopf KA35x10		<b>SG 11442</b> Beschwerung		<b>SG 11533</b> Box 110 mm
	<b>SG 11323</b> PT Schraube Senkkopf KA35x12		<b>SG 11443</b> Enddeckel viereckig		<b>SG 11534</b> Box Deckel 110 mm
	<b>SG 11355</b> Mitnehmerset 5-Serie		<b>SG 11446</b> Träger links 73 mm		<b>SG 11537</b> Trägerabdeckung rund links 110 mm
	<b>SG 11357</b> Mitnehmerset 24 V DC		<b>SG 11447</b> Träger rechts 73 mm		<b>SG 11538</b> Trägerabdeckung rund rechts 110 mm
	<b>SG 11426</b> Netzteil 24V / 2A inkl. Kabel mit EU/CH Stecker		<b>SG 11448</b> Träger links 73 mm		<b>SG 11539</b> Trägerabdeckung eckig links 110 mm
	<b>SG 11430</b> Montageprofil Fascia 73 mm		<b>SG 11449</b> Träger rechts 73 mm		<b>SG 11540</b> Trägerabdeckung eckig rechts 110 mm
	<b>SG 11431</b> Fascia rund 73 mm		<b>SG 11450</b> Träger links 73 mm		<b>SG 11542</b> Seitliche Führungsschiene
	<b>SG 11432</b> Fascia eckig 73 mm		<b>SG 11451</b> Träger rechts 73 mm		<b>SG 11546</b> Träger links 110 mm
	<b>SG 11433</b> Box 73 mm		<b>SG 11460</b> Deckel für Hirschmann Stecker		<b>SG 11547</b> Träger rechts 110 mm
	<b>SG 11434</b> Box Deckel 73 mm		<b>SG 11480</b> Funkwandsender 1-Kanal		<b>SG 11548</b> Träger links 110 mm
	<b>SG 11437</b> Trägerabdeckung rund links 73 mm		<b>SG 11490</b> Funkwandsender 5+1-Kanal		<b>SG 11549</b> Träger rechts 110 mm
	<b>SG 11438</b> Trägerabdeckung rund rechts 73 mm		<b>SG 11530</b> Montageprofil Fascia 110 mm		<b>SG 11550</b> Träger links 110 mm



**SG 11551**

*Träger rechts 110 mm*

---