

# SG 2090

---

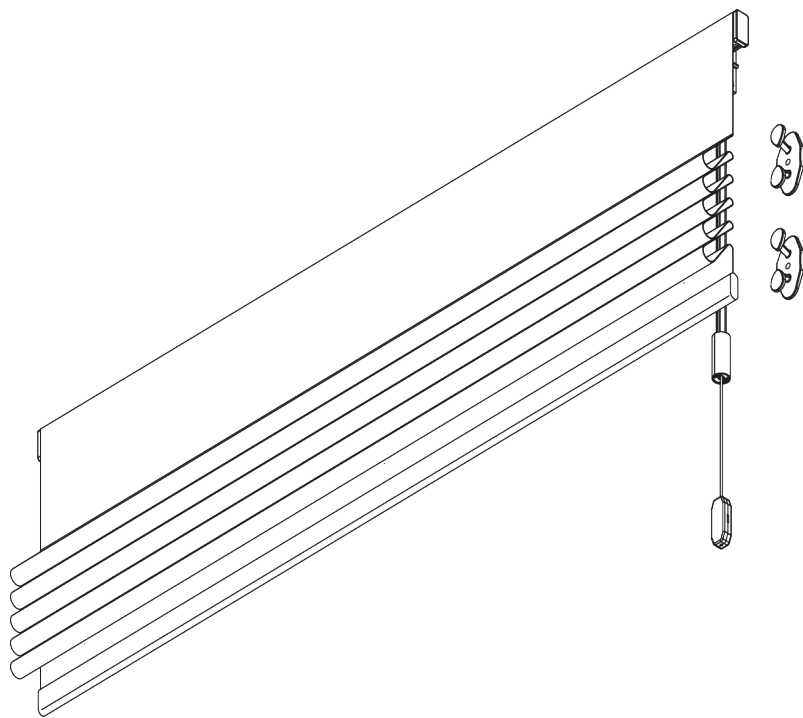

## PRODUKTINFORMATIONEN

- **Bedienung:** Schnur
- **Grösse:** S
- **Montage:** Wand
- **Farben:** weiss RAL 9016
- **Stoffe:** siehe Silent Gliss Stoffkollektion

### **Merkmale:**

- Einfache Montage am Fensterflügel

# SYSTEMSPEZIFIKATIONEN

## A. MASSE / GEWICHT



1 m

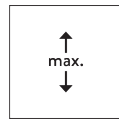

2 m



0.7 kg



2 m<sup>2</sup>

## B. PROFIL

### Profilinformationen

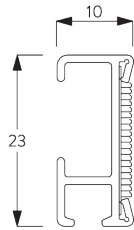

SG 2116

Velcroprofil

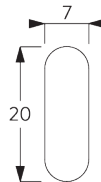

SG 2004

Beschwerung 20x7 mm

## C. MASSAUFNAHME

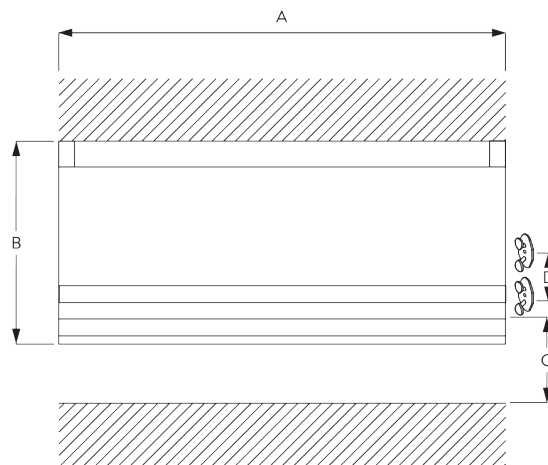

A: Systembreite

B: Systemhöhe

C: Schnuraufwickler SG 10742 min. 150 cm über Boden

D: 7 - 35 cm je nach Systemhöhe

# MONTAGE

## A. MONTAGE- INFORMATIONEN

Detaillierte Montageinformationen siehe  
Silent Gliss Website

### Montagepunkte

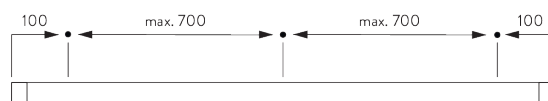

## B. WANDMONTAGE

Träger SG 3666

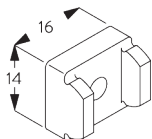
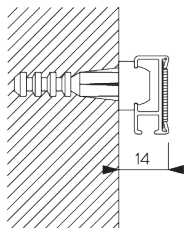

**SG 3666**

Träger

# SYSTEMOPTIONEN

## A. KONFEKTIONS- ARTEN

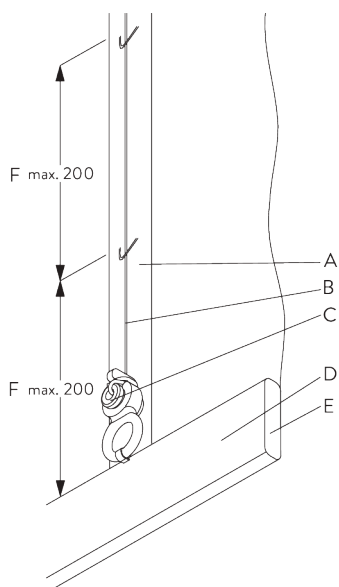

A: Laschenband SG 3074

B: Kordel SG 2216

C: Kindersicherheit Befestigungsset SG 3167















D: Hohlraum

E: Beschwerung SG 2004



F: Kindersicherheit: Distanz max. 200 mm

# KOMPONENTEN

## A. STANDARD KOMPONENTEN

	<b>SG 2004</b> Beschwerung 20x7 mm
	<b>SG 2116</b> Velcroprofil
	<b>SG 2131</b> Enddeckel
	<b>SG 2215</b> Öse
	<b>SG 2216</b> Schnur ø 0.85 mm
	<b>SG 2539</b> Flauschband
	<b>SG 2826</b> Kordelverbinder (2 x)
	<b>SG 3074</b> Laschenband
	<b>SG 3167</b> Kindersicherheitsklemmenset
	<b>SG 3185</b> Schnurarretierung
	<b>SG 3637</b> Kordel
	<b>SG 3666</b> Träger
	<b>SG 10742</b> Kindersicherheit Schnuraufwickler
	<b>SG 10745</b> Kindersicherheit Schnurverbinder

## B. OPTIONALE KOMPONENTEN

	<b>SG 3055</b> Haken
	<b>SG 11482</b> Ring